



Bisulfate – cluster based atmospheric pressure chemical ionization mass spectrometer for high-sensitivity (< 100 ppqV) detection of atmospheric dimethyl amine: proof-of-concept and first ambient data from boreal forest

M. Sipilä¹, N. Sarnela¹, T. Jokinen¹, H. Junninen¹, J. Hakala^{1,2}, M. P. Rissanen¹, A. Praplan^{1,3}, M. Simon⁴, A. Kürten⁴, F. Bianchi^{5,6}, J. Dommen⁵, J. Curtius⁴, T. Petäjä¹, and D. R. Worsnop^{1,7,8}

¹Department of Physics, P.O. Box 64, 00014 University of Helsinki, Finland

²Center for Atmospheric Particle Studies, Carnegie-Mellon University, Pittsburgh, PA 15213, USA

³Finnish Meteorological Institute, Finnish Meteorological Institute, P.O. Box 503, 00101 Helsinki, Finland

⁴Institute for Atmospheric and Environmental Sciences, Goethe-University of Frankfurt, Altenhöferallee 1, 60438 Frankfurt am Main, Germany

⁵Laboratory for Atmospheric Chemistry, Paul Scherrer Institute, 5232 Villigen, Switzerland

⁶Institute for Atmospheric and Climate Science, ETH Zürich, 8092 Zurich, Switzerland

⁷Department of Applied Physics, University of Eastern Finland, 70211 Kuopio, Finland

⁸Aerodyne Research Inc., Billerica, Massachusetts 01821, USA

Correspondence to: M. Sipilä (mikko.sipila@helsinki.fi)

Received: 2 January 2015 – Published in Atmos. Meas. Tech. Discuss.: 9 April 2015

Revised: 4 August 2015 – Accepted: 17 September 2015 – Published: 1 October 2015

Abstract. Atmospheric amines may play a crucial role in formation of new aerosol particles via nucleation with sulfuric acid. Recent studies have revealed that concentrations below 1 pptV can significantly promote nucleation of sulfuric acid particles. While sulfuric acid detection is relatively straightforward, no amine measurements to date have been able to reach the critical sub-pptV concentration range and atmospheric amine concentrations are in general poorly characterized. In this work we present a proof-of-concept of an instrument capable of detecting dimethyl amine (DMA) with concentrations even down to 70 ppqV (parts per quadrillion, 0.07 pptV) for a 15 min integration time. Detection of ammonia and amines other than dimethyl amine is discussed. We also report results from the first ambient measurements performed in spring 2013 at a boreal forest site. While minute signals above the signal-to-noise ratio that could be attributed to trimethyl or propyl amine were observed, DMA concentration never exceeded the detection threshold of ambient measurements (150 ppqV), thereby questioning, though not excluding, the role of DMA in nucleation at this location.

1 Introduction

Formation of secondary aerosol particles and cloud condensation nuclei in the atmosphere is initiated by nucleation. The role of sulfuric acid in nucleation is well established (e.g. Weber et al., 1995; Riipinen et al., 2007; Sipilä et al., 2010). However, sulfuric acid alone, or with water, does not nucleate efficiently enough to explain atmospheric nucleation rates (Kirkby et al., 2011); rather additional vapours are required to stabilize nucleating clusters. Ammonia (Ball et al., 1999; Vehkamäki et al., 2004; Kirkby et al., 2011) and amines (Kurten et al., 2008; Berndt et al., 2010, 2014; Erupe et al., 2011; Kirkby et al., 2011) are proposed to act as stabilizing agents of sulfuric acid clusters in atmospheric new particle nucleation. Recently, Almeida et al. (2013) showed that dimethyl amine concentrations below 1 pptV can dramatically enhance formation rates of new sulfuric acid particles (by several orders of magnitude); further, concentrations as low as just a few pptV can saturate the nucleation rate at atmospheric sulfuric acid concentrations. Enhancement of the particle formation rate is due to dimethyl amine's ability to

stabilize molecular sulfuric acid clusters, minimizing evaporation and enabling further growth (Almeida et al., 2013). Amines other than dimethyl amine can have a similar effect on nucleation (Berndt et al., 2014), but no experiments to date have probed the atmospherically important concentration range from ppqV to a few pptV.

Atmospheric measurements of amines are rare (Ge et al., 2011; Hanson et al., 2011; Yu et al., 2012; Freshour et al., 2014). Gas phase concentrations of these bases are usually low, and reliable measurement of atmospheric amine concentrations is far from sufficient to evaluate their role in atmospheric chemistry and physics. For example, from the SMEAR II field station (Hyytiälä, southern Finland; Hari and Kulmala, 2005), where the nucleation process has been seriously investigated for two decades, there are no reliable data for amine concentrations. First attempts to quantify concentrations of dimethyl or ethyl amine (DMA/EA) and trimethyl or propyl amine (TMA/PA) were performed by Sellegri et al. (2005), who applied an ambient pressure protonated water cluster-based chemical ionization mass spectrometer. Sellegri et al. (2005) reported observations of TMA with the concentration exceeding 10 pptV. However, that signal is most likely explained by an isotope of protonated acetone, occurring at the same integer mass as protonated TMA, making the observation questionable. No other amines were detected, suggesting that DMA concentrations were below few pptV. Note that DMA and EA (and also TMA and PA) have identical elemental composition and can thus not be separated from each other via mass spectrometry (MS).

More recently, amine concentrations at SMEAR II were published by Kieloaho et al. (2013). Amines collected on phosphoric acid-impregnated fibreglass filters (through a polytetrafluoroethylene (PTFE) filter) were subsequently analysed via liquid chromatography electrospray ionization mass spectrometry (LC-ESI-MS). They reported remarkably high gas phase amine concentrations, with DMA/EA and TMA/PA concentrations exceeding 100 pptV in autumn. Concentrations in spring time, relevant for comparison to our present work, were also reasonably high, up to a few tens of pptV for both DMA/EA and TMA/PA. This observation is in conflict with Schobesberger et al. (2015) who measured natural ion cluster distributions at SMEAR II during nucleation and found much more ammonia than amine composition in bisulfate–sulfuric acid–base clusters. Based on that observation and targeted laboratory experiments, Schobesberger et al. (2015) concluded that DMA concentration at the site should be less than 1 pptV. Obviously, this discrepancy should be resolved.

Despite some drawbacks, atmospheric pressure chemical ionization mass spectrometry (APCI-MS) as applied by Sellegri et al. (2005) is a promising approach for ultrahigh-sensitivity online gas phase amine detection. Nitric acid has been measured by using bisulfate ion as primary ion (Mauldin et al., 1998). For acids, such as sulfuric acid, detection limits down to 1 ppqV have been achieved with the

APCI-MS technique when the nitrate ion has been used as the primary ion (e.g. Eisele and Tanner, 1993; Jokinen et al., 2012). With the APCI-MS technique, interference from compounds in particle phase is minimized, whereas, in techniques utilizing sample collection and subsequent analysis (e.g. LC-MS), the separation between particle and gas phases is difficult.

APCI-MS approaches in use today rely on proton transfer reaction using protonated water clusters (Hanson et al., 2011) or protonated ethanol or acetone (Yu et al., 2012). Product ions which are guided through a differentially pumped section comprising collision dissociation chamber and an octopole ion guide are subsequently detected by a quadrupole mass spectrometer (Hanson et al., 2011; Yu et al., 2012). Using the above technique with protonated ethanol, Yu et al. (2012) reported a limit of detection (LOD) of 7 pptV for dimethyl amine and from 8 to 41 pptV for a series of other small alkylamines. Hanson et al. (2011) reported amine detection at “sub-pptV” levels by means of protonated water cluster ionization. This sub-pptV measurement range is still above the ppqV range reachable in the case of NO_3^- ionization detection of strong acids. These approaches may also suffer from flaws interfering with reliable amine detection and quantification: (i) outgassing of amines from gas lines and surfaces of chemical ionization system, (ii) non-collision limit charging efficiency, and (iii) uncertainty in identification of the elemental composition of detected ion due to insufficient mass resolution of the quadrupole mass spectrometer. Further problems in high-sensitivity amine measurements can be caused by amine contamination in the zero gas required for determination of instrument background.

Here we describe a chemical ionization system that utilizes ion-induced clustering of sulfuric acid and amines or ammonia, with ions detected with an atmospheric pressure interface time-of-flight mass spectrometer (APi-TOF, Junninen et al., 2010). This approach addresses the above issues that can complicate amine detection. Instrument response to ammonia and dimethyl amine was studied by calibrations performed in the CLOUD facility at CERN (e.g. Kirkby et al., 2011; Almeida et al., 2013). The instrument was used for quantification of ammonia and dimethyl amine as well as for qualitative detection of other amines in CLOUD at CERN and at the SMEAR II boreal forest field station in Hyytiälä, southern Finland, during the PEGASOS campaign in spring 2013.

2 Instrument

The instrument uses the nitrate ion atmospheric pressure chemical ionization (CI) system combined with an APi-TOF (Junninen et al., 2010) as described in Jokinen et al. (2012). Two modifications were made to the original instrument (Jokinen et al., 2012). First, due to multiple problems associated with use and transportation of radioactive materials, the

radioactive 10 MBq Am-241 ion source was replaced by a Hamamatsu (model L9490) soft (< 9.5 keV) X-ray tube. Second, a system for introducing gaseous sulfuric acid (H_2SO_4) in the sample flow was developed. A schematic representation of the instrument is shown in Fig. 1.

Operation of the chemical ionization ion-induced nucleation inlet is based on chemical ionization of sulfuric acid, H_2SO_4 ($\equiv\text{SA}$) by nitrate ions, NO_3^- , to form bisulfate ions, HSO_4^- ($\equiv\text{SA}^-$), and subsequent formation of bisulfate ion-sulfuric acid clusters:

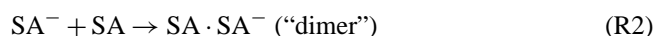

In the presence of dimethyl amine (DMA):



Further clustering of sulfuric acid takes place:

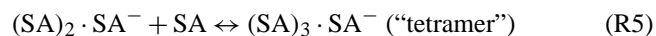

after which, besides DMA, ammonia (NH_3) can also stick to the clusters:

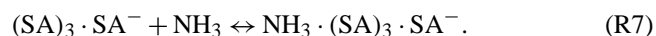

If sufficient sulfuric acid is present in the ambient sample it is possible that DMA (at very low concentrations) is bound to sulfuric acid. In that case the following reaction can also occur:



Clusters formed in reactions (R2)–(R8) can also decompose (evaporate), specifically in the reduced pressure in the API interface to the mass spectrometer. Evaporation rates for reactions (R1)–(R8) at +25 °C have been calculated to be: R2: 2.70×10^{-15} , R3: 5.60×10^{-3} , R4 and R8: 5.28×10^{-2} , R5: 24.1, R6: 1.89 and R7: 27.4 s^{-1} (Ortega et al., 2014). In reactions (R2)–(R4) and (R8), only the forward reaction needs to be considered. Due to their highly negative formation free energy, clusters formed in these reactions should be virtually non-evaporating in the 0.1 s residence time of the CI-system. $\text{DMA} \cdot (\text{SA}_3)\text{SA}^-$ formed in reaction (R6) should also be stable in our timescale with a lifetime of the cluster of the order of 0.5 s at +25 °C. However, the most probable fate of $\text{DMA} \cdot (\text{SA}_3)\text{SA}^-$ is not loss of SA but dissociation to neutral $\text{DMA} \cdot (\text{SA}_2)$ and $\text{SA} \cdot \text{SA}^-$. Therefore, addition of another SA to the highly stable $\text{DMA} \cdot (\text{SA}_2)\text{SA}^-$ may result in a loss of the

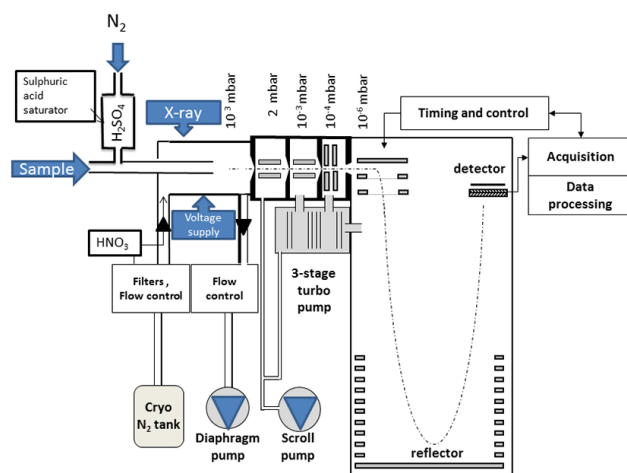

Figure 1. Schematic of the bisulfate – cluster chemical ionization atmospheric pressure interface time-of-flight mass spectrometer.

DMA altogether from the ion, especially when the instrument is operated at temperatures above +25 °C.

This assumption of stability does not apply to reactions (R5) and (R7), which complicate the detection of ammonia or amines which do not form stable adducts with $(\text{SA})_2\text{SA}^-$ similar to reaction (R4). The backward (evaporation) rates for reactions (R5) and (R7) will also be temperature sensitive. Thus, stable detection of compounds clustering only with $(\text{SA})_3 \cdot \text{SA}^-$ requires precise temperature control of the instrument.

Presence of $(\text{SA})_4 \cdot \text{SA}^-$ is unlikely at the $\sim +20$ °C operating temperature of our system (Ortega et al., 2014) but the clusters formed in reactions (R4), (R6) and (R7) can still add another SA molecule, forming a reasonably stable cluster. For example, for $\text{NH}_3 \cdot (\text{SA})_4 \cdot \text{SA}^-$, the evaporation rate is 2.29 s^{-1} (+25 °C, Ortega et al., 2014). Evaporation rates for $\text{DMA} \cdot (\text{SA})_4 \cdot \text{SA}^-$ are not reported. Attachment of a fifth sulfuric acid can give ion signals from the bases clustered with the SA trimer to pentamer (DMA) or with the tetramer or pentamer (NH_3). Further reactions where an additional DMA or NH_3 molecule attaches to cluster can occur but should not significantly affect the cluster distribution at expected low amine concentrations. These clusters containing multiple bases are readily detected with TOF-MS (see later).

Besides evaporation in the CI-system, clusters can decompose in energetic collisions in the electric fields of API quadrupoles. Also the cluster temperature will increase as a result of the collisions with the residual gas molecules thereby increasing the cluster evaporation rates. Detailed understanding of these effects is a hot topic in MS in general, but will require significant experimental and modelling efforts. Collision energies inside API are not very temperature dependent and thus once the fields are stable any de-clustering processes should be independent on environmental conditions. However, since the tuning significantly af-

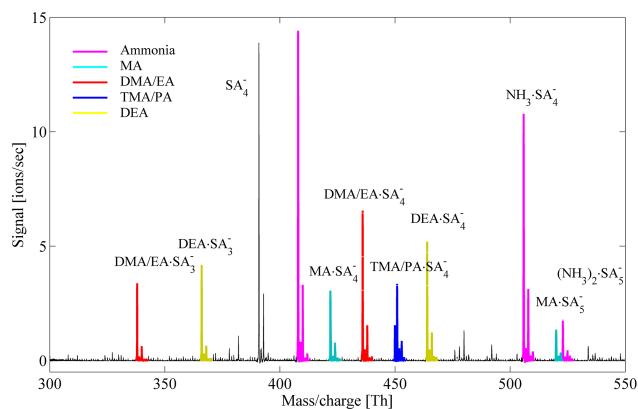

Figure 2. Dimethyl (DMA) and/or ethyl amine (EA) and diethyl amine (DEA) form stable clusters already with bisulfate “trimer”, whereas ammonia, methyl amine (MA) and trimethyl/propyl amine (TMA/PA) are detected with “tetramer” or larger clusters.

fects the ion transmission, fragmentation and evaporation, it is highly important that instruments are calibrated using the same settings as used in the field measurements.

In our experiment, electric fields inside the APi were optimized by manually tuning to provide maximum transmission and minimum fragmentation for the preferred mass range through the APi. In the present experiment we did not tune the instrument specifically for the purpose but we used the settings optimized for dimethyl amine–sulfuric acid nucleation experiments presented in Kürten et al. (2014). Therefore, the sensitivity of the instrument could still be improved by improving the APi transmission, especially in the mass range of 300–500 Da.

An overview of sticking preferences of various amines is shown in Fig. 2, depicting signals observed from laboratory indoor air mixed with a high concentration (several 10^{10} molecules cm^{-3}) of sulfuric acid vapour. While signals from DMA/EA, and diethyl/butyl amine (DEA/BA) are roughly as abundant with both the “trimer” and “tetramer”, the signals from NH_3 , MMA and TMA/PA are larger with the tetramer. This observation, albeit qualitative, indicates that DMA/EA and DEA/BA can be detected with higher sensitivity than ammonia and other small amines, because the “trimer” concentration in the system is significantly higher than that of the “tetramer” and larger sulfuric acid clusters.

Figure 3 shows the operation of the NO_3^- CI-system in more detail (Eisele and Tanner, 1993; Jokinen et al., 2011), including COMSOL computational fluid dynamical modelling. The system is comprised of a $3/4''$ inlet tube through which the sample is drawn with a flow rate of 10 L min^{-1} . A cylinder (coaxial to the inlet tube) is held at -130 V potential, separating the ion production region from the sample tube at ground potential. Still coaxial to that is an outer cylinder also kept at -130 V potential. An X-ray source irradiates

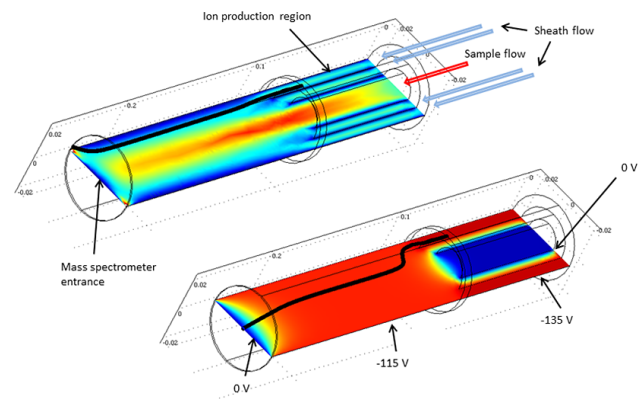

Figure 3. Operation principle of NO_3^- CI system used to produce bisulfate–sulfuric acid–base clusters from ambient amines and added sulfuric acid present in the sample flow. Upper plot represents the flow profile inside the system. Lower plot depicts the electric potential inside the system. In the upper panel, the black thick line shows the ion trajectory in the case where all electric potentials are set to zero and ions “go with the flow”. In the lower panel, the black thick line shows electric fields guiding ions toward the centreline of the ion source, allowing ions to mix and interact with the sample and eventually be transported to the pinhole of the mass spectrometer. The original concept as presented by Eisele and Tanner (1993) was adopted by Jokinen et al. (2011) and coupled to the APi-TOF mass spectrometer.

the space between these two cylinders through an aluminium window at the outer cylinder surface.

Sheath gas (ideally cryogenic N_2) flows at 20 L min^{-1} in the space between the cylinders and carries the ions produced downstream toward the ion–molecule reaction (IMR) tube. HNO_3 vapour added into the sheath flow promptly converts ions (formed from the X-rays) to $\text{NO}_3^- (\text{HNO}_3)_{n,n=0-2}$ ions or ion clusters. After entering the IMR region, an electric field (-110 V) between the IMR tube and the ground potential of the sample tube pushes the ions toward the sample (centreline) flow. Flows (sheath and sample) and electric field strength are balanced so that ions do not hit the sample tube wall, rather following an axial trajectory after entering the sample flow. Ions then interact with the sample flow for up to 340 ms before the electric field guides the ions into the 0.7 L min^{-1} flow through the pinhole into the atmospheric pressure interface of the TOF mass spectrometer.

The upper panel of Fig. 3 shows the flow velocity profile and nitrate ion trajectory in the absence of any electric potential in the drift tube or in the ion source. Ions travel close to the wall of the drift tube and exit the system with excess flow without interacting with the sample flow. In this case ions do not enter the mass spectrometer. The lower panel of Fig. 3 depicts the electric potential and the nitrate ion trajectory with the electric field on. The electric field and gas flows guide the ions from the ion production region to the centreline of the drift tube and eventually through the pinhole into the APi-

TOF. This nitrate ion based CI-API-TOF has been used in many recent laboratory and ambient air studies probing atmospheric chemistry and particle formation (e.g. Mauldin et al., 2012; Almeida et al., 2013; Ehn et al., 2014; Kürten et al., 2014). It has been shown to be highly sensitive toward sulfuric acid, sulfuric acid–amine clusters, and highly oxidized low volatility organics.

For direct amine measurements bisulfate–sulfuric acid clusters need to be generated first. Therefore, preceding the nitrate CI system, a flow ($1\text{--}2\text{ L min}^{-1}$) saturated in sulfuric acid vapour is mixed with the sample air. The saturator is a temperature-controlled ($+20\text{ }^{\circ}\text{C}$) rotating coaxial design (Fig. 4). The coaxial design allows a significantly more compact construction than a cylindrical design, while rotation continuously wets the walls with liquid sulfuric acid. This minimized unwanted wall effects; e.g. clean glass surfaces act as a sink to sulfuric acid vapour in contrast to liquid acid coatings. The glass tube connecting the rotating saturator to the sample inlet is as short as possible (5 cm). Mixing of sulfuric acid vapour and the sample gas then takes place in the 20 cm distance before the sample air enters the drift tube/ion interaction region. The detailed mixing process is not well known; it most likely involves both small-scale turbulence, as well as diffusion. Sulfuric acid concentration in the resulting mixture is in the range of $2\text{--}6 \times 10^{10}$ molecules cm^{-3} . After entering the IMR tube, reactions (R1)–(R8) result in prompt formation of bisulfate–sulfuric acid–base clusters for mass spectrometric analysis. Neutral sulfuric acid–base nucleation can occur both in the sample tube as well as in the IMR tube; in the latter, ionization of neutral clusters by NO_3^- or SA^- can also occur. However, since ion-induced clustering is significantly faster (due to the ion-enhanced collision rate) than neutral cluster formation, neutral processes likely play a minor role.

Three problems that have previously limited amine measurements (see the Introduction) are, to a large extent, solved with the present approach. Firstly, outgassing of amines from flow system walls is effectively prevented by acid coating of all gas lines and CI-source surfaces. Stainless steel surfaces in the sheath gas line are also extensively coated with HNO_3 added to sheath gas flow. Such acid coating activates tube walls with respect to base deposition and prevents desorption. Only the wall of 3/4 inch diam. 40 cm long inlet tube extending to ambient atmosphere is not actively acidified. Also the use of cryogenic nitrogen as a sheath gas and stainless steel surfaces in instrument as well as in gas lines between the nitrogen Dewar and the instrument help in decreasing the background signals.

The second problem, the non-collision limit charging efficiency, is solved for DMA by the choice of the ionization method. DMA sticks to sulfuric acid trimer and tetramer without significant evaporation. This, however, is not the case with ammonia. Other amines also need to be thoroughly investigated.

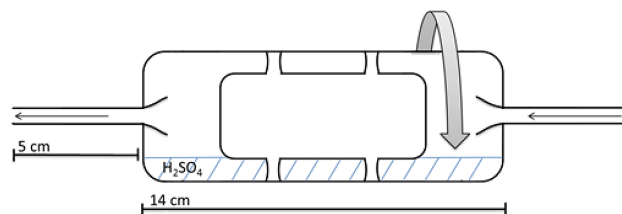

Figure 4. Schematic of the rotating sulfuric acid saturator. The saturator is connected to the sample tube as in Fig. 1.

The third problem, identification of the atomic composition of detected ion, is solved by application of high mass resolution TOF mass spectrometer. The mass resolution of the API-TOF is $\sim 4000\text{ Th/Th}$ and the mass accuracy is $< 20\text{ ppm}$. This is facilitated in data post-processing utilizing high-resolution peak identification and isotopic patterns (tofTools, Junninen et al., 2010). Combined with high selectivity of the ionization method, many unwanted compounds are not ionized, or resolved in a very clean mass spectrum.

3 Sensitivity studies

Sensitivity was studied in the CLOUD experiment at CERN. For a detailed description of the facility see Kirkby et al. (2011) and Almeida et al. (2013). Briefly, the CLOUD facility is designed for studying nucleation and growth of secondary aerosol, cloud droplet activation and freezing and the effect of galactic cosmic radiation on those processes, under precisely defined laboratory conditions. The CLOUD chamber itself is a 26 m^3 electropolished stainless steel tank equipped with a UV-light system and precise temperature control. Lifetime of condensable gases against wall loss is in the range of few minutes. Air inside the chamber is prepared from cryogenic nitrogen and oxygen. Input gases are precisely controlled and the gas composition is continuously monitored by an extensive suite of analysing instruments.

DMA and/or NH_3 were mixed with the flows of cryogenic oxygen and nitrogen, prior to entering the chamber. The calculation of the volume mixing ratios is based on a balance between the flow of DMA into the chamber and its loss to the chamber walls. While the amount of the inflowing DMA is directly obtained from the mass flow controller settings, the wall loss rate is derived from two independent methods. The first one relates the measured wall loss rate of sulfuric acid to the one of dimethylamine taking into account that the loss rate is proportional to the square root of the diffusivity for the different molecules (Crump and Seinfeld, 1981). The second method involves directly measured decay rates when the flow of DMA is shut off after a sufficiently long period when DMA was present at high mixing ratios (several tens of pptv). These measured decay rates were obtained using nitrate cluster ions for the DMA detection. A detailed description of the DMA quantification by this method will be given

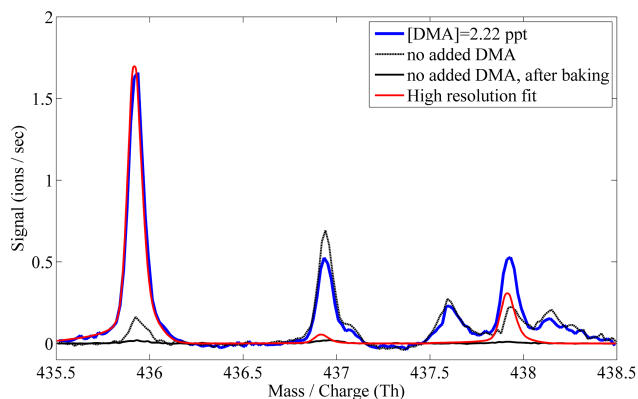

Figure 5. Mass spectra with $[DMA] = 2.22$ pptV, the lowest studied $[DMA]$; and the background signal (in the absence of added DMA) without and after the baking and flushing of the CLOUD chamber. Integration time is 15 min. The principal peak is located at 435.92 Th; the first of the isotopes 436.92 Th is partly overlapping with signal from an unidentified compound. The second isotope at 437.92 Th is, however, clearly visible. The signal at 437.6 Th originates from a chlorine-containing substance, whose source is unknown. Lowest detection limit was defined as three times the background signal at main peak (435.92 Th) and was found to be 70 ppqV (0.07 pptV). Practically, ultimate sensitivity is limited by contamination in blank air or on inlet surfaces. A high-resolution fit of DMA is also shown and represents the ideal distribution of signal in the absence of overlapping signals from other compounds.

in forthcoming publications. For the scope of this paper it is sufficient to note that just the relative change in the DMA signal is required to obtain the wall loss rate, while the absolute measurement is not a necessity. Overall, the different methods for determination of the DMA mixing ratios, including also the direct IC measurement (Praplan et al., 2012), yield consistent results and the error bars in Fig. 6 indicate the uncertainty.

3.1 Sensitivity for DMA

The CIMS system described in this work was calibrated against the concentration in the CLOUD chamber with $[DMA]$ ranging from 2.2 to 34.9 pptV. These experiments included simultaneous generation of sulfuric acid (from SO_2 oxidation) at atmospheric levels to investigate of sulfuric acid–DMA nucleation. Sulfuric acid present in the chamber could affect DMA detection via clustering with the DMA which could slightly affect the measurement to a pure DMA system. However, since sulfuric acid concentrations were representative of the atmosphere, the presence of sulfuric acid makes the calibration system more atmospherically relevant. In Fig. 5, example mass spectra around mass/charge 436 Th, the mass of the DMA-tetramer cluster, show signals with $[DMA] = 2.22$ pptV and with no added DMA (i.e. chemical background of the system with CLOUD tank filled with cryogenic N_2 / O_2 mixture) without special clean-

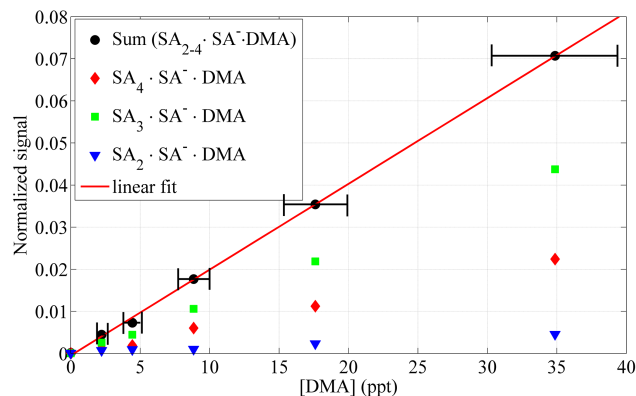

Figure 6. Response of bisulfate cluster signal to $[DMA] = 0$ –35 pptV. DMA concentration in the CLOUD tank was adjusted by adjusting the DMA-containing flow to the chamber.

ing procedure and after cleaning the chamber by baking at $\sim 100^\circ C$ and flushing with cryogenic air in presence of O_3 and OH (UV-light) to desorb and/or oxidize any contaminants on the chamber wall. The main isotope at 437.92 Th is clearly visible demonstrating the sensitivity and the resolution of the method. The isotopic distribution and the exact mass of the main peak allow unambiguous identification of the atomic composition of the cluster ion.

The response of the instrument as a function of $[DMA]$ is shown in Fig. 6. DMA is observed in the clusters with $(SA)_{2-4} \cdot SA^-$, with $DMA \cdot (SA)_3 \cdot SA^-$ being the most abundant cluster. Summing up the detected clusters yields the total signal of DMA. The signal is normalized by $(SA)_2 \cdot SA^-$, the dominant reagent ion at the end of the IMR tube. The $(SA)_2 \cdot SA^-$ should be the ion to which most of the DMA attach according to reaction (R4) (before the further attachment of sulfuric acid), since DMA cannot attach to $(SA)_{0-1} \cdot SA^-$ and larger clusters $(SA)_{>2} \cdot SA^-$ are far more sparse. It is possible that a significant fraction of neutral DMA molecules enter the IMR region bound to sulfuric acid. In that case, reaction (R8) can play a role as well, and normalization to sum of bisulfate dimer and trimer might be appropriate. However, the results in Fig. 6 are independent on the choice of normalization method.

All detected ions correlate extremely well with the DMA concentration calculated from the flows injected in the chamber. The correlation between the normalized sum of detected clusters and DMA concentration is excellent, $R^2 = 0.9994$. Such linearity demonstrates the performance of our instrument and, also, the superior control and performance of the CLOUD chamber facility. $DMA \cdot (SA)_{2-4} \cdot SA^-$ clusters are also very stable and, therefore, temperature variations in IMR tube do not alter cluster distributions or detection efficiency. The limit of detection (defined as three times the background signal) was found to be 73 ppqV (or 0.07 pptV) for 15 min integration, representing roughly a 10- to 100-fold improvement in comparison to other existing techniques (Hanson et

al., 2011; Yu et al., 2012). It should also be noted that with time-of-flight mass spectrometer all signals are integrated simultaneously while, in contrast, with quadrupole MS only one mass is detected at a time. Thus, if several amines are to be measured, the LOD is unaffected. A calibration coefficient is obtained from the slope of the linear fit, $C = 491$ pptV. The calibration coefficient is used to convert the signal to concentration according to

$$[\text{DMA}] = C \times \frac{\sum_{n=2-4} \text{SA}^- \text{SA}_n \text{DMA}}{\text{SA}^- \text{SA}_2}. \quad (1)$$

3.2 Sensitivity for ammonia

Sensitivity for ammonia was studied exactly as for DMA. Ammonia easily evaporates from the “trimer” SA cluster, unlike DMA; and since the “tetramer” cluster is relatively unstable at near room temperature in the IMR tube, much lower sensitivity is expected. Calibration results were far more scattered possibly due to either fluctuating (or poorly defined NH_3 concentration, at low $[\text{NH}_3]$) in the CLOUD chamber or temperature variations in the IMR tube affecting cluster stability. Instrument temperature was not controlled, e.g. drifted with ambient temperature in the facility; therefore, temperature-sensitive evaporation rates would be reflected in ammonia detection sensitivity. If temperature fluctuations were the cause of variable signals, a LOD of few tens of pptV could be achieved with proper temperature control. Using only the highest ammonia concentration (90 pptV) used in calibration experiment, an approximate calibration coefficient of $C = 2.9 \times 10^4$ pptV was obtained. This coefficient is subject to significant uncertainty, at least a factor of 5. Major improvements are required before an instrument can be used for quantitative ammonia measurements. In the case of ammonia, the signal is normalized to “tetramer” and the equation

$$[\text{NH}_3] = C \times \frac{\sum_{n=3-4} \text{SA}^- \text{SA}_n \text{NH}_3}{\text{SA}^- \text{SA}_3} \quad (2)$$

is used for converting the signal to concentration.

4 Application to field measurements at SMEAR II

Field measurements were conducted at the Smear II boreal forest field station (Hari and Kulmala, 2005) at Hyytiälä in southern Finland during the PEGASOS campaign, 1 April–15 June 2013. Initially ambient air filtered with amine-specific gas mask filter (pumped using a standard membrane pump) was used to provide the 20 L min^{-1} sheath air flow for the ion source. Background signals from amines and ammonia were unacceptably high, even though the acidified walls of the sheath gas lines likely scavenged a significant fraction of those bases. Therefore, the sheath air was promptly substituted with a flow of cryogenic nitrogen. Figure 7 shows how

the change in sheath gas affected the signals, also indicating the sensitivity to any artificial source of amines, a problem associated with amine measurements in general.

A portion of time series of ammonia and DMA is shown in Fig. 8, with concentrations calculated with the calibration coefficients obtained from the CERN calibration. Backgrounds, measured daily by substituting cryogenic nitrogen in the sample flow, are not subtracted; rather they are shown in the shaded blue regions. In the case of ammonia, N_2 flushing yielded a factor of 5–10 decrease in detected signal, corresponding to background “concentration” of few tens of pptV (using the nominal calibration coefficient determined above). Average ammonia concentration during the stable operation period with N_2 sheath gas (from 7 May to 2 June, 2013) was approximately 610 pptV, subject to significant uncertainty of at least a factor of 5 due to the uncertainty (see above) in the calibration coefficient. Thus, ammonia measurements reported here should only be taken as a proof-of-concept to monitor ammonia together with DMA and possibly other amines.

In the case of DMA, signals (always) increased during background N_2 flushing, reaching levels corresponding to 250 ppqV (0.25 pptV) in concentration (Fig. 8, see also Fig. 9a). The source of DMA is likely somewhere in the stainless steel line, mass flow controller or pressure regulator between the N_2 Dewar and the sample inlet; or, less likely, from contamination (during flow switching) in the 40 cm long non-acidified part of the sample tube. Nevertheless, since no meaningful background level could be determined, the observed ambient signals, corresponding to 40 to 150 ppqV amine concentration, may be all due to chemical background in the instrument and, thus, not a single data point can be reliably attributed to DMA concentrations in the ambient atmosphere. An upper limit for DMA concentration can be obtained if we assume that the only artificial source of DMA was the zero air fed to the instrument during the background measurement. In that case the upper limit of [DMA] ranged from a few tens up to approximately 1500 ppqV during the whole measurement period when the instrument worked stably (7 May to 2 June 2013). However, since we had no calibration standard available in field measurements, our results should be treated with caution and considered as a proof-of-concept rather than a solid fact.

During this time period, several nucleation events were observed. Our observation of low DMA levels indicates that the nucleation process unlikely involved DMA to a significant extent (Almeida et al., 2013) and other amines or non-nitrous organics are possibly needed to explain the new particle formation rates.

Though the DMA concentration was found to be reasonably low, or even negligible, other amines, TMA or possibly PA, exceeded the detection (background) threshold. Since no calibration exists for amines other than DMA, those signals cannot be reliably converted to concentrations. However, since bisulfate–sulfuric acid–DMA clusters are very stable, it

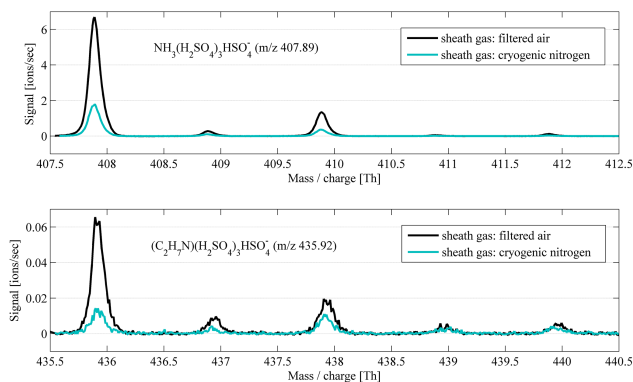

Figure 7. Purity of sheath gas is important for high-sensitivity detection. Cryogenic N_2 resulted in 3–5 times lower background than ambient air filtered with particle filter and amine-specific gas mask filter. Still both ammonia and dimethylamine are visible in the spectra, with signals corresponding to several tens of pptV for ammonia and ~ 100 ppqV for dimethylamine. Data are taken with zero air (N_2) fed into the sample inlet.

is likely that other amines are detected with similar or lower sensitivity as DMA. Thus, we can report the lower limit concentrations for other detected amines by applying the calibration coefficient obtained for DMA. Example mass spectra from (a) DMA/EA, (b) ammonia, (c) TMA/PA and (d) a C4-amine (e.g. DEA) are presented together with corresponding zero measurements in Fig. 9. Signals from DMA/EA and C-4 amine increase during zero gas flushing, while ammonia and TMA/PA show clear and moderate reduction upon zero measurement, respectively, the latter suggesting the presence of TMA/PA with concentrations larger than a few tens or hundreds of ppqV. However, for these extremely small signals, exact mass determination is not definitive; nor could the isotopes be resolved from the background spectrum. Therefore, the identification of the compound as TMA/PA is not certain.

Though the role of DMA in particle nucleation seems uncertain, the possible detection of TMA/PA leaves open the possibility that other amines might contribute to nucleation. Our result regarding [DMA] agrees with Schobesberger et al. (2015), suggesting sub-pptV DMA concentrations. However, our values are in serious conflict with the concentrations of DMA/EA reported by Kieloaho et al. (2013). The reason could be that the entire signal in Kieloaho et al. (2013) was due to EA while we were completely insensitive to EA – for example, we could only detect DMA. However, it would be surprising that, while we obviously detect several amines, including DMA, MMA, TMA/PA and DEA (Fig. 2), the sensitivity for EA would be so poor. Another possibility could be in particle phase amine evaporation from the PTFE filter used to remove particulate matter from the sample in Kieloaho et al. (2013). Also, we performed our measurements at the open area of the measurement container field of SMEAR II, some 10–20 m from the uniform forested area, while Kieloaho et

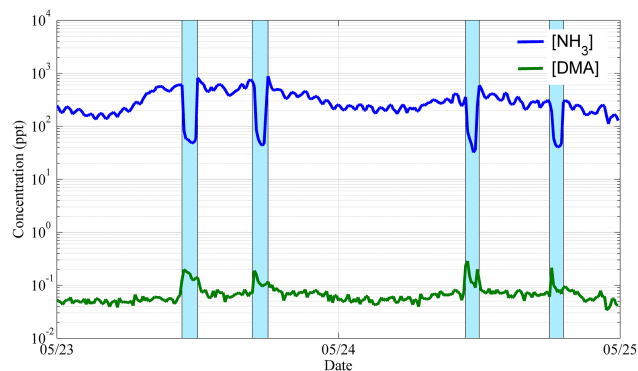

Figure 8. Portion of a time series measured at SMEAR II boreal forest field station. While ammonia concentration exceeds the detection threshold determined by the zero measurement (indicated by the blue shaded regions), the DMA signal increases when zero air is fed into the instrument, indicating that DMA concentrations in ambient atmosphere were at maximum 150 ppqV during the measurement period. Evaluation of ambient concentration is limited by apparent contamination in “zero air” from N_2 flushing of inlet lines. That is, the [DMA/EA] depicted here represents the upper limit of ambient concentration.

al. (2013) sampled inside the forest below the canopy. Amine lifetimes against oxidation and adsorption to particle phase should be at least a few minutes (even with unity uptake coefficient), and therefore the small difference in measurement location should not cause such a major discrepancy.

5 Conclusions

A bisulfate–cluster based atmospheric pressure chemical ionization system was developed and integrated into a time-of-flight mass spectrometer. Calibrations demonstrated that, under ideal conditions, there is a limit of detection for dimethylamine (DMA) of less than 70 parts per quadrillion (ppqV) for a 15 min integration. Sensitivity of the system for DMA is approximately 10- to 100-fold higher than reported for other existing methods. Performance results from minimization of amine outgassing from system surfaces, collision-limited ionization and high mass resolution of the applied mass spectrometer. Extreme cleanliness of added gas flows is also crucial.

Besides DMA, other small alkyl amines and ammonia can be detected. Detection of ammonia with the present system, however, suffers from imperfect temperature control resulting in varying stability of bisulfate–sulfuric acid–ammonia clusters which is likely reflected in variable instrument response. Further efforts are required to understand the clustering dynamics of amines other than DMA and to calibrate the instrument against well-quantified concentration of these amines. In field measurements at a boreal forest site, DMA concentration was below ~ 150 ppqV throughout the whole measurement period in May–June 2013, suggesting that it is

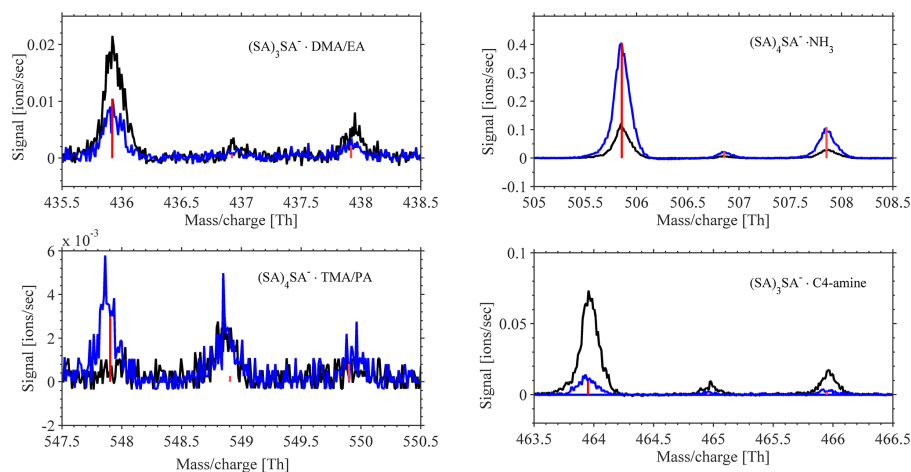

Figure 9. Examples of signals representing ambient measurement (blue) and zero (black) measurement. Zero gas (cryo N_2) contains more gas phase DMA/EA and a C4-amine (e.g. DEA) than ambient air. Only ammonia and potentially trimethyl/propyl amine (TMA/PA) signals exceed the signals from zero gas measurement. Red bars show the exact masses of isotopes and expected isotopic distribution normalized to the height of the main peak.

unlikely that DMA played a major role in atmospheric nucleation of new aerosol particles observed simultaneously at the site. However, since no calibration standard was available during field measurements, our results should be treated with caution and considered as a proof-of-concept. Tentative observations on the existence of other amines (trimethyl and/or propyl amine) leave open the possibility of amine contribution to new particle formation.

Acknowledgements. We thank CERN for supporting CLOUD with technical and financial resources. Support of the Academy of Finland (251427, 139656, 264375, Finnish Centre of Excellence 141135) is acknowledged. Support from the Helsinki Institute of Physics is acknowledged. This research was partially funded by the European Commission 7th Framework Programme via PEGASOS (FP7-ENV-2010-265148), ACTRIS (Aerosols, Clouds, and Trace gases Research InfraStructure Network), Marie Curie Initial Training Network “CLOUD-ITN” and “CLOUDTRAIN-ITN”, and Finnish Funding Agency for Innovation (TEKES) through the APCI project. Tinja Olenius, Oona Kupiainen-Määttä, Kenty Ortega, Hanna Vehkamäki, Antti-Jussi Kieloaho and Markku Kulmala are acknowledged for useful discussions. We thank the tofTools team for providing tools for mass spectrometry analysis. The Finnish Antarctic Research Programme is acknowledged for providing high-quality facilities for preparing the manuscript.

Edited by: F. Stroh

References

- Almeida, J., Schobesberger, S., Kurten, A., Ortega, I. K., Kupiainen-Määttä, O., Praplan, A. P., Adamov, A., Amorim, A., Bianchi, F., Breitenlechner, M., David, A., Dommen, J., Donahue, N. M., Downard, A., Dunne, E., Duplissy, J., Ehrhart, S., Flagan, R. C., Franchin, A., Guida, R., Hakala, J., Hansel, A., Heinritzi, M., Henschel, H., Jokinen, T., Junninen, H., Kajos, M., Kangasluoma, J., Keskinen, H., Kupc, A., Kurten, T., Kvashin, A. N., Laaksonen, A., Lehtipalo, K., Leiminger, M., Leppä, J., Loukonen, V., Makhmutov, V., Mathot, S., McGrath, M. J., Nieminen, T., Olenius, T., Onnela, A., Petäjä, T., Riccobono, F., Riipinen, I., Rissanen, M., Rondo, L., Ruuskanen, T., Santos, F. D., Sarnela, N., Schallhart, S., Schnitzhofer, R., Seinfeld, J. H., Simon, M., Sipilä, M., Stozhkov, Y., Stratmann, F., Tome, A., Trostl, J., Tsagkogeorgas, G., Vaattovaara, P., Viisanen, Y., Virtanen, A., Vrtala, A., Wagner, P. E., Weingartner, E., Wex, H., Williamson, C., Wimmer, D., Ye, P. L., Yli-Juuti, T., Carslaw, K. S., Kulmala, M., Curtius, J., Baltensperger, U., Worsnop, D. R., Vehkamäki, H., and Kirkby, J.: Molecular understanding of sulphuric acid-amine particle nucleation in the atmosphere, *Nature*, 502, 359–363, 2013.
- Ball, S. M., Hanson, D. R., Eisele, F. L., and McMurry, P. H.: Laboratory studies of particle nucleation: Initial results for H_2SO_4 , H_2O , and NH_3 vapors, *J. Geophys. Res.*, 104, 23709–23718, 1999.
- Berndt, T., Stratmann, F., Sipilä, M., Vanhanen, J., Petäjä, T., Mikkilä, J., Grüner, A., Spindler, G., Lee Mauldin III, R., Curtius, J., Kulmala, M., and Heintzenberg, J.: Laboratory study on new particle formation from the reaction $OH + SO_2$: influence of experimental conditions, H_2O vapour, NH_3 and the amine tert-butylamine on the overall process, *Atmos. Chem. Phys.*, 10, 7101–7116, doi:10.5194/acp-10-7101-2010, 2010.
- Berndt, T., Sipilä, M., Stratmann, F., Petäjä, T., Vanhanen, J., Mikkilä, J., Patokoski, J., Taipale, R., Mauldin III, R. L., and Kulmala, M.: Enhancement of atmospheric H_2SO_4/H_2O nucle-

- ation: organic oxidation products versus amines, *Atmos. Chem. Phys.*, 14, 751–764, doi:10.5194/acp-14-751-2014, 2014.
- Crump, J. G. and Seinfeld, J.: Turbulent deposition and gravitational sedimentation of an aerosol in a vessel of arbitrary shape, *J. Aerosol Sci.*, 12, 405–415, 1981.
- Ehn, M., Thornton, J. A., Kleist, E., Sipilä, M., Junninen, H., Pullinen, I., Springer, M., Rubach, F., Tillmann, R., Lee, B., Lopez-Hilfiker, F., Andres, S., Acir, I.-H., Rissanen, M., Jokinen, T., Schobesberger, S., Kangasluoma, J., Kontkanen, J., Nieminen, T., Kurtén, T., Nielsen, L. B., Jørgensen, S., Kjaergaard, H. G., Canagaratna, M., Dal Maso, M., Berndt, T., Petäjä, T., Wahner, A., Kerminen, V., Kulmala, M., Worsnop, D. R., Wildt, J., and Mentel, T. F.: A large source of low-volatility secondary organic aerosol, *Nature*, 506, 476–479, 2014.
- Eisele, F. L. and Tanner, D. J.: Measurement of the gas phase concentration of H₂SO₄ and methane sulfonic acid and estimates of H₂SO₄ production and loss in the atmosphere, *J. Geophys. Res.*, 98, 9001–9010, 1993.
- Erupe, M. E., Viggiano, A. A., and Lee, S.-H.: The effect of trimethylamine on atmospheric nucleation involving H₂SO₄, *Atmos. Chem. Phys.*, 11, 4767–4775, doi:10.5194/acp-11-4767-2011, 2011.
- Freshour, N. A., Carlson, K. K., Melka, Y. A., Hinz, S., Panta, B., and Hanson, D. R.: Amine permeation sources characterized with acid neutralization and sensitivities of an amine mass spectrometer, *Atmos. Meas. Tech.*, 7, 3611–3621, doi:10.5194/amt-7-3611-2014, 2014.
- Ge, X., Wexler, A. S., and Clegg, S. L.: Atmospheric amines – Part I, A review, *Atmos. Environ.*, 45, 524–546, 2011.
- Hanson, D. R., McMurry, P. H., Jiang, J., Tanner, D., and Huey, L. G.: Ambient pressure proton transfer mass spectrometry: detection of amines and ammonia, *Environ. Sci. Technol.*, 45, 8881–8888, 2011.
- Hari, P. and Kulmala, M.: Station for measuring ecosystem-atmosphere relations (SMEAR II), *Boreal Environ. Res.*, 10, 315–322, 2005.
- Jokinen, T., Sipilä, M., Junninen, H., Ehn, M., Lönn, G., Hakala, J., Petäjä, T., Mauldin III, R. L., Kulmala, M., and Worsnop, D. R.: Atmospheric sulphuric acid and neutral cluster measurements using CI-API-TOF, *Atmos. Chem. Phys.*, 12, 4117–4125, doi:10.5194/acp-12-4117-2012, 2012.
- Junninen, H., Ehn, M., Petäjä, T., Luosujärvi, L., Kotiaho, T., Koskiainen, R., Rohner, U., Gonin, M., Fuhrer, K., Kulmala, M., and Worsnop, D. R.: A high-resolution mass spectrometer to measure atmospheric ion composition, *Atmos. Meas. Tech.*, 3, 1039–1053, doi:10.5194/amt-3-1039-2010, 2010.
- Kieloaho, A.-J., Hellén, H., Hakola, H., Manninen, H.-E., Nieminen, T., Kulmala, M., and Pihlatie, M.: Gas-phase alkylamines in a boreal Scots pine forest air, *Atmos. Environ.*, 80, 369–377, 2013.
- Kirkby, J., Curtius, J., Almeida, J., Dunne, E., Duplissy, J., Ehrhart, S., Franchin, A., Gagne, S., Ickes, L., Kürten, A., Kupc, A., Metzger, A., Riccobono, F., Rondo, L., Schobesberger, S., Tsagkogeorgas, G., Wimmer, D., Amorim, A., Bianchi, F., Breitenlechner, M., David, A., Dommen, J., Downard, A., Ehn, M., Flagan, R. C., Haider, S., Hansel, A., Hauser, D., Jud, W., Junninen, H., Kreissl, F., Kvashin, A., Laaksonen, A., Lehtipalo, K., Lima, J., Lovejoy, E. R., Makhmutov, V., Mathot, S., Mikkilä, J., Minginette, P., Mogo, S., Nieminen, T., Onnela, A., Pereira, P., Petäjä, T., Schnitzhofer, R., Seinfeld, J. H., Sipilä, M., Stozhkov, Y., Stratmann, F., Tome, A., Vanhanen, J., Viisanen, Y., Vrtala, A., Wagner, P. E., Walther, H., Weingartner, E., Wex, H., Winkler, P. M., Carslaw, K. S., Worsnop, D. R., Baltensperger, U., and Kulmala, M.: The role of sulfuric acid, ammonia and galactic cosmic rays in atmospheric aerosol nucleation, *Nature*, 476, 429–433, 2011.
- Kürten, A., Jokinen, T., Simon, M., Sipilä, M., Sarnela, N., Junninen, H., Adamov, A., Almeida, J., Amorim, A., Bianchi, F., Breitenlechner, M., Dommen, J., Donahue, N. M., Duplissy, J., Ehrhart, S., Flagan, R. C., Franchin, A., Hakala, J., Hansel, A., Heinritzi, M., Hutterli, M., Kangasluoma, J., Kirkby, J., Laaksonen, A., Lehtipalo, K., Leiminger, M., Makhmutov, V., Mathot, S., Onnela, A., Petäjä, T., Praplan, A. P., Riccobono, F., Rissanen, M. P., Rondo, L., Schobesberger, S., Seinfeld, J. H., Steiner, G., Tomé, A., Tröstl, J., Winkler, P. M., Williamson, C., Wimmer, D., Ye, P., Baltensperger, U., Carslaw, K. S., Kulmala, M., Worsnop, D. R., and Curtius, J.: Neutral molecular cluster formation of sulfuric acid-dimethylamine observed in real time under atmospheric conditions, *P. Natl. Acad. Sci.*, 111, 15019–15024, 2014.
- Kurtén, T., Loukonen, V., Vehkamäki, H., and Kulmala, M.: Amines are likely to enhance neutral and ion-induced sulfuric acid-water nucleation in the atmosphere more effectively than ammonia, *Atmos. Chem. Phys.*, 8, 4095–4103, doi:10.5194/acp-8-4095-2008, 2008.
- Mauldin III, R. L., Tanner, D. J., and Eisele, F. L.: A new chemical ionization mass spectrometer for the fast measurement of gas phase nitric acid in the atmosphere, *J. Geophys. Res.*, 103, 3361–3367, 1998.
- Mauldin III, R. L., Berndt, T., Sipilä, M., Paasonen, P., Petäjä, T., Kim, S., Kurtén, T., Stratmann, F., Kerminen, V.-M., and Kulmala, M.: A new atmospherically relevant oxidant of sulphur dioxide, *Nature*, 488, 193–197, 2012.
- Ortega, I. K., Olenius, T., Kupiainen-Määttä, O., Loukonen, V., Kurtén, T., and Vehkamäki, H.: Electrical charging changes the composition of sulfuric acid-ammonia/dimethylamine clusters, *Atmos. Chem. Phys.*, 14, 7995–8007, doi:10.5194/acp-14-7995-2014, 2014.
- Praplan, A. P., Bianchi, F., Dommen, J., and Baltensperger, U.: Dimethylamine and ammonia measurements with ion chromatography during the CLOUD4 campaign, *Atmos. Meas. Tech.*, 5, 2161–2167, doi:10.5194/amt-5-2161-2012, 2012.
- Riipinen, I., Sihto, S.-L., Kulmala, M., Arnold, F., Dal Maso, M., Birmili, W., Saarnio, K., Teinilä, K., Kerminen, V.-M., Laaksonen, A., and Lehtinen, K. E. J.: Connections between atmospheric sulphuric acid and new particle formation during QUEST III–IV campaigns in Heidelberg and Hyytiälä, *Atmos. Chem. Phys.*, 7, 1899–1914, doi:10.5194/acp-7-1899-2007, 2007.
- Schobesberger, S., Franchin, A., Bianchi, F., Rondo, L., Duplissy, J., Kürten, A., Ortega, I. K., Metzger, A., Schnitzhofer, R., Almeida, J., Amorim, A., Dommen, J., Dunne, E. M., Ehn, M., Gagné, S., Ickes, L., Junninen, H., Hansel, A., Kerminen, V.-M., Kirkby, J., Kupc, A., Laaksonen, A., Lehtipalo, K., Mathot, S., Onnela, A., Petäjä, T., Riccobono, F., Santos, F. D., Sipilä, M., Tomé, A., Tsagkogeorgas, G., Viisanen, Y., Wagner, P. E., Wimmer, D., Curtius, J., Donahue, N. M., Baltensperger, U., Kulmala, M., and Worsnop, D. R.: On the composition of ammonia-sulfuric-acid ion clusters during aerosol particle formation, *Atmos. Chem. Phys.*, 15, 55–78, doi:10.5194/acp-15-55-2015, 2015.

- Sellegri, K., Hanke, M., Umann, B., Arnold, F., and Kulmala, M.: Measurements of organic gases during aerosol formation events in the boreal forest atmosphere during QUEST, *Atmos. Chem. Phys.*, 5, 373–384, doi:10.5194/acp-5-373-2005, 2005.
- Sipilä, M., Berndt, T., Petäjä, T., Brus, D., Vanhanen, J., Stratmann, F., Patokoski, J., Mauldin, L., Hyvärinen, A.-P., Lihavainen, H., and Kulmala, M.: The Role of Sulphuric Acid in Atmospheric Nucleation, *Science*, 327, 1243–1246, 2010.
- Vehkamäki, H., Napari, I., Kulmala, M., and Noppel, M.: Stable ammonium bisulphate clusters in the atmosphere, *Phys. Rev. Lett.*, 93, 148501, doi:10.1103/PhysRevLett.93.148501, 2004.
- Weber, R. J., McMurry, P. H., Eisele, F. L., and Tanner, D. J.: Measurement of expected nucleation precursor species and 3–500-nm diameter particles at Mauna Loa observatory, Hawaii, *J. Atmos. Sci.*, 52, 2242–2257, 1995.
- Yu, H., McGraw, R., and Lee, S.-H.: Effects of amines on formation of sub-3 nm particles and their subsequent growth, *Geophys. Res. Lett.*, 39, L02807, doi:10.1029/2011GL050099, 2012.