

Measurements of OH and HO₂ concentrations during the MCMA-2006 field campaign – Part 1: Deployment of the Indiana University laser-induced fluorescence instrument

S. Dusanter¹, D. Vimal^{1,*}, P. S. Stevens¹, R. Volkamer^{2,3,4}, and L. T. Molina^{2,5}

¹Center for Research in Environmental Science, School of Public and Environmental Affairs, and Department of Chemistry, Indiana University, Bloomington, IN 47405, USA

²Massachusetts Institute of Technology, Cambridge MA, USA

³University of California at San Diego, La Jolla CA, USA

⁴University of Colorado at Boulder and CIRES, Boulder CO, USA

⁵Molina Center for Energy & the Environment, La Jolla CA, USA

* now at: Molecular Physics Laboratory, SRI International, Menlo Park, CA, USA

Received: 5 June 2008 – Published in Atmos. Chem. Phys. Discuss.: 17 July 2008

Revised: 22 January 2009 – Accepted: 17 February 2009 – Published: 5 March 2009

Abstract. Measurements of tropospheric hydroxyl (OH) and hydroperoxy (HO₂) radicals were made during the MCMA (Mexico City Metropolitan Area) field campaign as part of the MILAGRO (Megacity Initiative: Local and Global Research Observations) project during March 2006. These radicals were measured using a laser-induced fluorescence instrument developed at Indiana University. This new instrument takes advantage of the Fluorescence Assay by Gas Expansion technique (FAGE) together with direct excitation and detection of OH at 308 nm. HO₂ is indirectly measured as OH by titration with NO inside the fluorescence cell. At this stage of development, IU-FAGE is capable of detecting 3.9×10^5 molecule/cm³ of both OH and HO₂, with a signal to noise ratio of 1, an averaged laser power of 10-mW and an averaging time of 5-min. The calibration accuracies (1σ) are $\pm 17\%$ for OH and $\pm 18\%$ for HO₂ using the water-vapor photolysis/O₂ actinometry calibration technique.

OH and HO₂ concentrations were successfully measured at an urban site in Mexico City, with observed concentrations comparable to those measured in other polluted environments. Enhanced levels of OH and HO₂ radicals were observed on several days between 09:30–11:00 a.m. and suggest an intense photochemistry during morning hours that may be due to elevated sources of HO_x (OH+HO₂) and a fast cycling between the radicals under the high NO_x (NO+NO₂) conditions of the MCMA.

1 Introduction

Hydroxyl (OH) and hydroperoxy (HO₂) radicals have been a subject of considerable interest since it was suggested that OH was produced at sufficient concentrations in the troposphere to initiate the oxidation of volatile organic compounds (VOCs) and other trace gases (Levy, 1971, 1972). Such processes lead to the production of organic peroxy radicals (RO₂), which are converted back into OH via HO₂ through successive reactions involving nitric oxide (NO). Because of its high reactivity, OH controls lifetime and fate of most ambient trace gases and therefore is an important oxidant in the gas-phase photochemistry of the troposphere.

Urban environments are typically characterized by high concentrations of nitrogen oxides (NO_x=NO+NO₂) and VOCs. These areas exhibit a complex oxidation chemistry involving odd hydrogen radicals (HO_x=OH+HO₂), VOCs, and NO_x that leads to the formation of ozone and secondary aerosols. Understanding the coupling between HO_x and NO_x in the presence of VOCs is essential for the design of efficient strategies seeking to reduce the impact of anthropogenic emissions on air quality over urbanized areas. Measurements of OH and HO₂ can provide a critical test of our understanding of this fast photochemistry (Heard and Pilling, 2003).

Laser-induced fluorescence is a versatile technique for the sensitive detection of simple molecules such as OH, as well as HCHO and NO₂, both in the laboratory and in the free atmosphere (Clemmitshaw, 2004). This technique has been used successfully to measure HO_x radicals in the



Correspondence to: S. Dusanter
(sdsuante@indiana.edu)

stratosphere (Wennberg et al., 1995) and in the troposphere (Heard and Pilling, 2003) using two different excitation-detection schemes. Initial instruments were based on OH excitation at 282 nm and red-shifted fluorescence detection at 308 nm, allowing optical filtering of the OH fluorescence from the intense scattered laser-light. This detection scheme has been applied with success in the stratosphere, but is not applicable in the troposphere where the higher ambient pressure and the high content of water-vapor lead to the production of OH from the photo-dissociation of O₃ at 282-nm (R1) by the laser beam, and the subsequent reaction of the photo-product, O(¹D), with water-vapor:



The laser-generated OH can be excited within the same laser pulse that produced it, resulting in a quadratic dependence of the detected OH signal with laser power.

In order to reduce the O₃-water photolytic interference, while keeping a high instrumental sensitivity, a second detection technique based on OH excitation and detection at 308 nm and at low-pressure is widely used for tropospheric measurements (Heard and Pilling, 2003). Ambient air is expanded inside a detection cell and OH is probed by low-energy laser pulses generated at a high repetition-rate. This sampling technique, known as Fluorescence Assay by Gas Expansion (FAGE), exhibits several advantages: (i) Sampling at low pressure reduces the concentration of both O₃ and H₂O in the sampled air mass, as well as other trace gases, reducing the production of laser-generated OH as well as unwanted secondary chemistry (Stevens et al., 1994). (ii) The fluorescence lifetime of the excited OH radical is extended to hundreds of nanoseconds due to lower quenching rates, allowing temporal filtering of the weak OH fluorescence from the scattered laser light. In addition, excitation of the OH radical at 308-nm instead of 282-nm further reduces the photolytic interference by a factor of approximately 30 due to a lower O₃ absorption cross section and a lower quantum yield for the production of O(¹D) (Stevens et al., 1994). Note that the use of a high repetition-rate laser system that delivers low-energy pulses, but a high average power, also reduces the photolytic production of OH from each pulse. Instruments based on the FAGE design with resonant detection of OH at 308-nm have proven their ability to perform measurements of tropospheric OH by reducing the photolytic interference below negligible levels (Heard and Pilling, 2003).

Laser-Induced Fluorescence instruments as well as Chemical Ionization Mass Spectrometer (CIMS) and Differential Optical Absorption Spectrometer (DOAS) instruments have been used extensively to characterize the HO_x chemistry in a variety of different environments (Heard and Pilling, 2003). However, only a few investigations have focused on urban areas (Table 1). In addition to the local impacts of urban

air quality, understanding the photochemistry of urban environments is important, as they may have a strong impact on regional air quality and global climate change (Molina and Molina, 2004).

In this paper we report the description of a HO_x instrument developed at Indiana University (IU-FAGE) based on the Fluorescence Assay by Gas Expansion technique and the resonant detection scheme at 308-nm. This instrument was first deployed as part of the Mexico City Metropolitan Area (MCMA) field campaign during March of 2006, and successfully measured daytime OH and HO₂ concentrations. The qualitative behavior of HO_x concentrations during MCMA-2006 is examined and compared to observations from previous urban field campaigns. A more detailed analysis of the data, including model comparisons and a discussion of the radical budget will be presented in a companion paper (Dusanter et al., 2009).

2 Instrument description

The IU-FAGE instrument takes advantage of the Laser-Induced Fluorescence Assay by Gas Expansion technique (LIF-FAGE) to probe the OH radical at low pressure together with excitation and detection of OH at 308-nm. IU-FAGE is equipped with a high repetition-rate laser system, a sampling cell for ambient air expansion, a reference cell for wavelength calibration, and a gated detection system.

2.1 High repetition rate laser system and laser-light propagation

A schematic of IU-FAGE instrument is shown in Fig. 1. The laser light is generated at a repetition rate of 6 kHz using a dye laser (Lambda Physik, Scanmate 1) pumped by the second harmonic of a pulsed Nd:YAG laser (Spectra Physics Navigator II YHP40-532Q). The primary emission of the dye laser was found to be optimum using a mixture of Rhodamine 640 in isopropanol. Approximately 7 W of laser light at 532-nm from the Nd:YAG laser produces 150–200 mW at 616-nm from the dye laser. The 616-nm emission is frequency doubled by a BBO (Beta Barium Borate) crystal, and the second harmonic is separated from the fundamental by a system of prisms. The resulting laser beam at 308-nm exhibits a pulse-width of approximately 20-ns and an averaged laser power of 1–15 mW. A planoconvex lens, tilted to correct the laser beam astigmatism, focuses the light onto an optical fiber launcher assembly employed to propagate the laser-beam to the sampling cell. Two different optical fibers (Thor Labs), 2 and 12-m long, are used depending on the experiment requirements. These fibers, with their optical launchers, exhibit respective transmittances of 45% and 37%.

Two quartz plates are positioned at an incident angle of 45° in the path of the laser beam after the BBO crystal. The

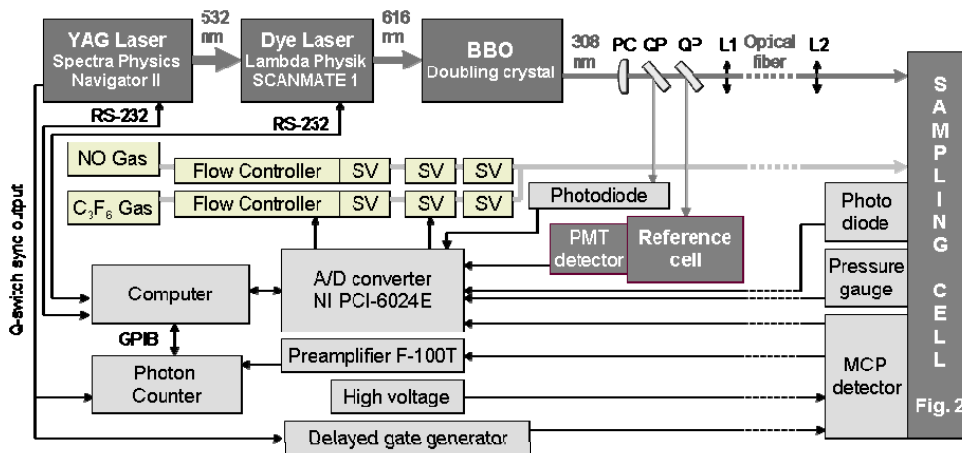

Fig. 1. Schematic diagram of the IU-FAGE instrument. PC: planoconvex lens, QP: quartz plate, L1 and L2: optical launchers, SV: solenoid valve, MCP: microchannel plate.

Table 1. Chronologic compilation of the urban and suburban field campaigns that include HO_x measurements. The numbers in brackets are median values. P(O₃) is the value at the peak. ^a P(O₃) calculated from measured HO₂ and RO₂ concentrations. ^b P(O₃) calculated from measured HO₂ concentrations. ^c Range of HO₂/OH ratios from binned NO. ^d P(O₃) calculated from a box model that took into account all the reactions converting NO into NO₂. ^e The contribution of HONO was calculated after subtraction of the OH+NO sink. * The MCMA-2003 HO_x concentrations have been revised (Mao et al., 2009), and are approximately a factor of 1.6 times higher than the previously reported values shown here.

Field Campaigns	Measured OH (10 ⁶ cm ⁻³)	Measured HO ₂ (10 ⁶ cm ⁻³)	Measured (ppb) O ₃ , NO, NO ₂	HO ₂ /OH	P(O ₃) (ppb/h)	Daytime model comparison Calculated/Measured	RO _x Sources	References
LAFRE, Los Angeles Free Radical Experiment Claremont, Los Angeles (CA), September 1993	4.0–6.0	1.6–2.0	Peak O ₃ : 140–200 NO: 20–90			Lumped mechanism: CAL, OH: 1.5 at midday, HO ₂ : >1 at midday	HONO, O ₃ , HCHO, dialdehyde, O ₃ -alkene	(George et al., 1999)
BERLIOZ, Berliner Ozoneexperiment Pabsthum, Berlin, July–August 1998	2.0–8.0 (3.5)	0.5–8.5 (2.2)	O ₃ :– NO: <0.1–1.5 NO ₂ : 1.5–5.5	0–200	(8) ^b	OH: NO _x >5 ppb: good for MCM and RACM NO _x <5 ppb: 1.25 at midday (MCM), 2 (RACM) HO ₂ : good (MCM), 1.4 (RACM)	O ₃ , HCHO, HONO, O ₃ -alkene	(Platt et al., 2002) (Holland et al., 2003) (Konrad et al., 2003)
PUMA, Pollution of the Urban Midlands Atmosphere Birmingham (UK), June–July 1999	2.0–9.0	1.5–10.0	O ₃ : 29.0–41.2 NO: 2.7–4.2 NO ₂ : 6.6–14.4	20–160		MCM 3.1, OH: 0.58, HO ₂ : 0.56	OVOCs, O ₃ -alkene, HCHO, HONO, O ₃	(Heard et al., 2004) (Emmerson et al., 2005a) (Emmerson et al., 2005b)
SOS, Southern Oxidants Study Nashville (Tennessee), June–July 1999	7.0–20 (10.0)	2.8–22.4 (7.5)	O ₃ : <1–90 NO: 0.1–70 NO ₂ : –		(14.5) ^b	Lumped mechanism, OH: 0.75, HO ₂ : 0.64	O ₃ , HCHO, HONO	(Martinez et al., 2003)
PUMA, Pollution of the Urban Midlands Atmosphere Birmingham (UK), January–February 2000	0.5–4.0	1.5–10.0	O ₃ : 13.2–22.0 NO: 4.5–20.5 NO ₂ : 9.3–22.9			MCM 3.1, OH: 0.50, HO ₂ : 0.49	O ₃ -alkene, OVOCs, HONO	(Heard et al., 2004) (Emmerson et al., 2005a) (Emmerson et al., 2005b)
PMTACS-NY, PM _{2.5} Technology Assessment and Characterization Study–New York, June–August 2001	5.0–20.0 (7.0)	0.5–6.0 (1.0)	Peak O ₃ : (48) NO _x : (20–48) Peak O ₃ : (115) Peak NO _x : (86)	(5–70) ^c	(20) ^b	RACM, OH: 0.91, HO ₂ : 0.81, agreement better at low NO _x	HONO, O ₃ -alkene	(Ren et al., 2003b) (Ren et al., 2003c)
MCMA-2003, Mexico City Metropolitan Area Mexico City, April 2003	5.0–8.0 (7.0) [*]	3.0–12.0 (7.4) [*]	Average O ₃ : 20.8–95.2 Average NO: 0.3–9.9 Average NO ₂ : 1.5–13.2	8–250 (20–150) ^e	(48) ^b	RACM (morning-midday), OH: 0.93–1.30, HO ₂ : 0.86–1.27 MCM 3.1, OH: 1.24, HO ₂ : 1.07	OVOCs, O ₃ -alkene, O ₃ , HONO, HCHO	(Shirley et al., 2006) (Volkamer et al., 2007) (Emmerson et al., 2007)
TORCH, Tropospheric Organic Chemistry experiment London, England, July–August 2003	1.2–7.5	0.2–3.3	Average O ₃ : 20.8–95.2 Average NO: 0.3–9.9 Average NO ₂ : 1.5–13.2	2–500 (10–70) ^e	(7.2) ^d	MCM 3.1, OH: 1.24, HO ₂ : 1.07	OVOCs, O ₃ -alkene, O ₃ , HONO, HCHO	(Emmerson et al., 2007)
PMTACS-NY, PM _{2.5} Technology Assessment and Characterization Study–New York, January–February 2004	(1.4)	(0.2)	Peak O ₃ : (20) NO: (7–30) NO ₂ : (15–30)	50–400		RACM, Median OH: 1.02, Median HO ₂ : 0.17	HONO, ^e O ₃ -alkene	(Ren et al., 2006)
IMPACT IV, Integrated Measurements Program for Aerosol and oxidant Chemistry in Tokyo, Japan, Jan–Feb 2004	(1.5)	(1.1 ppt)	Peak O ₃ : (30) NO: 1–70 (8.1) NO ₂ : (18.2)	1–80 (3–30) ^c		RACM, OH: 0.93–1.23, HO ₂ : 0.48–0.88	O ₃ -alkene, OVOCs, HONO ^f	(Kanaya et al., 2007)
IMPACT L, Integrated Measurements Program for Aerosol and oxidant Chemistry in Tokyo, Japan, Jul–Aug 2004	(6.3)	(5.7 ppt)	Peak O ₃ : (30) NO: 0.1–20 (2.6) NO ₂ : (9.4)	1–700 (5–400) ^c		RACM, OH: 0.86, HO ₂ : 1.29	OVOCs, O ₃ , O ₃ -alkene, HONO ^f	(Kanaya et al., 2007)
MCMA-2006, Mexico City Metropolitan Area Mexico City, March 2006	2.0–15.0 (4.6)	0.6–4.5 (1.9)	Peak O ₃ : (90) Peak NO: (200) Peak NO ₂ : (80)	1–300 (8–70) ^e	(80) ^b	Dusanter et al., 2009		This work

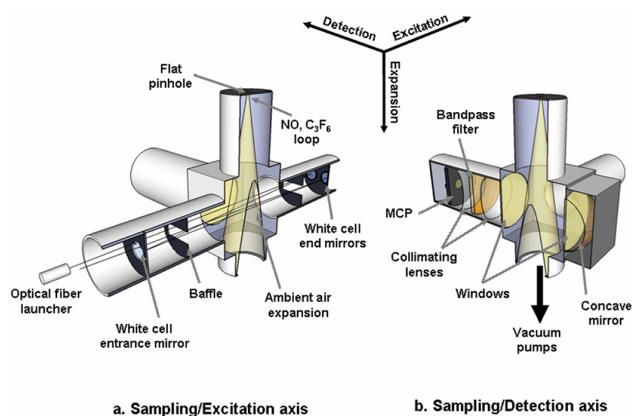

Fig. 2. Cross-sections of the detection cell. The left figure displays the intersection between the sampled air mass and the excitation beam through the multipass cell. The right figure displays the detection axis.

first plate is used to deliver a small fraction of the UV light to a reference cell for wavelength calibration. The second plate allows monitoring the laser power at the output of the dye laser using a photodiode detector (UDT-555UV, OSI Optoelectronics) equipped with an interference filter (308-nm, ESCO products).

2.2 Sampling and reference Cells

The sampling cell design is based on the Ground-based Tropospheric Hydrogen Oxides Sensor developed at Pennsylvania State University (Stevens et al., 1994; Mather et al., 1997; Faloon et al., 2004). The current version of IU-FAGE uses a single axis for successive measurement of OH and HO₂ radicals (Fig. 2). The sampling cell consists of a central aluminum cube 11.4-cm in length, a cylindrical inlet nozzle (5-cm diameter, 20-cm long) and a multi-pass cell (White design). Inner walls are anodized in order to minimize light scattering.

Ambient air is pumped through a flat pinhole approximately 1-mm in diameter and is expanded along the length of the nozzle. A loop injector is located downstream the sampling inlet to allow the addition of either nitric oxide (NO, Matheson, 99.8%) or perfluoropropylene (C₃F₆, Matheson, 99.8%). These gases are respectively used to convert ambient HO₂ into OH or to scavenge ambient OH before the detection axis. The loop was designed with radial holes pointing towards the center of the nozzle to improve the gas mixing and to avoid potential wall reactions. Three mechanical vacuum pumps (Leybold D16B, 20 m³ h⁻¹) are connected in parallel to provide a flow rate of 10 SLPM (Standard Liter Per Minute), allowing air to be refreshed rapidly at the detection axis. The internal pressure is kept at 5.3±0.2 hPa and is monitored at the bottom of the cell by an absolute capacitance gauge (MKS 0–10 Torr, better than 1% precision).

The operating pressure was chosen for the following reasons: (i) an early FAGE instrument exhibited an unusual drop in sensitivity with an increase of the ambient water-vapor mixing ratio by operating the sampling cell at a lower pressure (Hofzumahaus et al., 1996; Creasey et al., 1997). This effect was attributed to radical scavenging on water cluster formed in the cold zone of the gas expansion. (ii) The sensitivity is strongly dependent on the operating pressure (Faloon et al., 2004); however, this dependence is minimized around 5.3 hPa and potential pressure changes during field measurements would induce less variation on the sensitivity than at other pressures.

A White-type multi-pass cell is used inside the sampling cell to improve the instrumental sensitivity by increasing the amount of generated fluorescence. It consists of three 1-in.-diameter mirrors, UV coated for high reflectivity ($R > 99.9\%$) at 308-nm with a base length of 250-cm. The entrance mirror has two cut-outs allowing the laser beam to enter and leave the sampling cell. The light delivered by the optical fiber is focused at the entrance mirror and is propagated 24 times through the sampled air mass before exiting the cell. The laser beam is then focused on an external photodiode detector for laser power monitoring (UDT-555UV, OSI Optoelectronics, interference filter at 308-nm, ESCO products). The multi-pass cell is designed with internal square openings allowing the laser beam to go back and forth between the mirrors while trapping scattered photons. Dry nitrogen is continuously flushed through each end of the multi-pass cell to avoid contamination of the mirrors.

A single-pass reference cell is employed to get the maximum spectral overlap between the laser emission and the OH transition. The cell is made out of aluminum and is equipped with 2 suprasil windows for laser beam access. A rotary pump (Leybold D16B, 20 m³ h⁻¹) is used to keep the reference cell under vacuum and a high concentration of hydroxyl radical is produced by thermal dissociation of water-vapor at low pressure using a hot alumel filament. The resulting OH fluorescence is collected by a Hamamatsu photomultiplier tube (H6180-01) equipped with an interference filter at 308-nm (ESCO products).

2.3 Gated photon-counting detection

The laser beam encounters the sampled air mass approximately 20-cm below the sampling point to ensure that OH is probed when the rotational temperature has been thermalized to ambient temperature (Stevens et al., 1994; Kanaya et al., 2001). OH is probed under thermalized conditions for several reasons. (i) The low temperature in the cold zone of the gas expansion may lead to radical scavenging on water-clusters (Hofzumahaus et al., 1996; Creasey et al., 1997). (ii) The instrumental sensitivity depends on the Boltzmann distribution of OH and the quenching rates of the excited state by N₂, O₂ and H₂O. These parameters are strongly dependent on the temperature (Bailey et al., 1997) and geometry

variations of the gas expansion may lead to OH sensitivity changes during field measurements. Probing OH in a thermalized region minimizes these issues.

The OH fluorescence is collected by an optical train (Fig. 2) at a right angle to the excitation beam through a solid angle that has been approximately doubled by using a concave mirror opposite the detector (100-cm diameter, 40-cm focus lens, Melles Griot). Two coated lenses ($f=75$ -mm, CVI Laser) allow careful imaging and spatial filtering of the fluorescence onto the detector. A band-pass filter centered at 308 nm (Barr Associates, transmission 65%, bandwidth 5-nm, OD>5 at other wavelengths), is inserted in the optical train to selectively reduce scattered photons from solar light, red-shifted fluorescence of the walls, and potential fluorescence of other chemical species.

The detection system is shown in Fig. 1 and is composed of a time-gated micro-channel plate photomultiplier tube (Hamamatsu R5916U-50), a preamplifier/discriminator (F-100T, Advanced Research Instruments) and a high-speed photon counter (SRS400, Stanford Research Systems). The intense laser light that is scattered when the laser is fired can saturate the micro-channel plate (MCP) and lead to the generation of after-pulses which deteriorate the instrumental sensitivity (Creasey et al., 1998). To avoid detector saturation, the MCP gain is reduced by a factor of 10^5 during the laser pulse, and switched to the highest gain 60-ns after the laser pulse. The gain is kept high for approximately $1\text{-}\mu\text{s}$ in order to collect most of the OH fluorescence, and is then reduced until the next laser-pulse. The signal from the MCP is amplified and filtered by a pulse-height discriminator that delivers TTL pulses for each detected photon. The photon counter is set with a timing gate using a delay and width for the 2-m long fiber of 130 and 260-ns after the laser pulse. These parameters were optimized to give the best signal-to-noise ratio by discriminating electronic noise and scattered laser-light against the weak OH fluorescence, and are different when the 12-m long fiber is used. Reflection of the laser light between the two ends of the fiber generates a second light pulse which occurs approximately 160-ns later than the main pulse, similar to that observed by Faloona et al. (2004). In order to reduce the detected scattered light from this secondary pulse, the MCP gain-switch and the photon counting gate are respectively delayed 70 and 90-ns later than that used for the 2-m long fiber.

The photoelectron pulses from the reference channel are detected and quantified by a counter on a National Instrument acquisition board (PCI-6024E). The reference channel signal (reference cell and associated electronics) was observed to cross-talk with the ambient channel (sampling cell and associated electronics) when the reference signal was too high. This issue was fixed by attenuating both the laser light propagated inside the reference cell and the amplitude of the photoelectron pulses. Two different tests are systematically performed during ambient OH measurements to ensure that cross-talking between the counters has been efficiently elim-

inated: (i) S_{OH} in the sampling cell is alternatively measured with and without laser excitation inside the reference cell. (ii) S_{OH} is measured during air-zero tests when IU-FAGE is sampling clean air provided by a flow-tube interfaced on the top of the nozzle. During MCMA 2006, none of these tests showed a significant offset in the measured net OH signal.

2.4 Automation and field control

IU-FAGE is automated using a combination of GPIB, DAQ (National Instrument, PCI-6024E) and RS232 interfaces. A custom software program coded using LabView (National Instruments) allows monitoring the HO_x concentrations in real-time. The program includes several routines to acquire the excitation spectrum of OH, adjust the wavelength to maximize overlap between the laser emission and the OH transition, and perform periodic modulation cycles between on-resonance and off-resonance measurements. The program also switches between OH and HO₂ measurements by controlling the NO addition inside the sampling nozzle. A mass flow controller (MKS 1179A) is used to regulate the NO flow, and leakage during OH measurements is prevented by the internal valve of the flow controller and two additional solenoid valves connected in series. At the end of an HO₂ measurement, the valve of the flow controller is immediately closed, 10 s later the first solenoid valve located downstream of the flow controller is turned off, and the second solenoid valve is closed after another 10 s. In a similar manner, a flow of C₃F₆ can be added to check for potential photolytic interferences during OH measurements. This is discussed in detail in the HO_x-specificity section.

The time-resolution is controlled by the photon counter, which sums the detected photons from the ambient channel for 1 s and transfers the data to the computer. This event initiates the acquisition of 1 s averaged parameters such as the signal from the reference channel, the sampling cell pressure, the photodiode signals, NO and C₃F₆ flow rates, and the signals from ancillary monitors.

2.5 Measurement principle

The FAGE instrument is a non-zero background technique and the background signal must be measured to derive the net signal produced by the OH fluorescence. The procedure employed is based on successive modulation cycles during which the wavelength is successively tuned on-resonance and off-resonance with an OH transition. The on- and off-resonance measurements are usually acquired for 10-s in order to catch the rapid variation of the background signal due to potential changes in the solar scattered light entering the nozzle (ambient light going through the nozzle).

The Q₁(3) transition of OH at 308.1541 nm was chosen because the Q₁(3)-Q₂₁(3)-P₁(1) triplet is easily identified and this transition exhibits one of the strongest absorption cross sections around 308 nm ($\sigma=1.4\times 10^{-16}$ cm², P=1013 hPa,

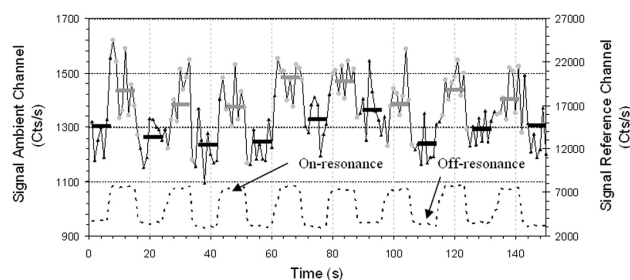

Fig. 3. Segment of raw data recorded on 15 March with a 10-s modulation cycle. The solid black line corresponds to the signal recorded from the ambient channel. The grey circles and the grey symbols are the 1-s on-resonance signal and the averaged 10-s signal, respectively. The black triangles and the black symbols are the 1-s background signal and the 10-s averaged background signal. The dashed black line corresponds to the signal recorded from the reference channel and indicates when the measurements are performed on- and off-resonance.

$T=300$ K) (Dorn et al., 1995). In addition, a rapid switching between $Q_1(3)$ and $P_1(1)$ allows for a check for potential spectral interferences from other ambient species. The fluorescence is a one photon process that is linear with both the laser power and the OH density, provided that the OH transition is not saturated. Stevens et al. (1994) observed a 10% saturation for the $Q_1(3)$ transition at $1.4 \mu\text{J}/\text{cm}^2$ (assuming a laser beam radius of 0.5 cm). The maximum laser power of 15-mW produced by the IU-FAGE instrument leads to an average value of approximately 6.5-mW of UV light inside the sampling cell when the 2-m long fiber is used. The laser fluence calculated for the maximum laser power is $1.1 \mu\text{J}/\text{cm}^2$ (beam radius of 0.5-cm), below the 10%-limit determined by Stevens et al. (1994).

Figure 3 displays a segment of raw data recorded on 15th March 2006 during the MCMA-2006 field campaign. One half of the measurement time is devoted to measuring the background signal, while the remaining time is dedicated to measuring the on-resonance signal. The off-resonance signal is an average of the two backgrounds surrounding the on-resonance measurement ($\lambda_{\text{on-resonance}} - 0.004$ nm and $\lambda_{\text{on-resonance}} + 0.004$ nm). Tests performed in the laboratory have shown that less than 1% of the on-resonance OH signal was measured at the background wavelengths under the working conditions.

The net OH signal (S_{OH}) is inferred from subtracting the off-resonance signal from the on-resonance signal. The advantage of measuring the background as an averaged surrounding off-resonance signal is twofold: (i) The laser power varies slightly with wavelength, which can lead to small differences in the background signal between the on- and off-resonance measurements. This may lead to a miscalculation of the net OH signal if the background signal is only measured on one side of the OH transition, especially if the background signal is largely due to scattered laser-light. (ii) Com-

paring the two surrounding background signals allows checking for potential spectral interferences which may be induced by other fluorescing species. An interesting example can be found in Martinez et al. (2004). The authors observed that naphthalene exhibits a transition at a slightly longer wavelength than the $Q_1(2)$ transition of OH and fluoresce around 308-nm. Potential spectral interferences in the measurements presented here are discussed in the HO_x-specificity section.

Hydroperoxy radical measurements are based on the rapid gas-phase reaction of HO₂ with nitric oxide and subsequent detection as OH (R3):



A flow of pure NO (Matheson, better than 99% purity) is added through a loop injector located just below the sampling point after passing through an ascarite trap. The optimum NO flow (1 SCCM) used to convert the HO₂ radicals before the detection axis is a trade-off between the conversion of HO₂ into OH and the removal of OH by reaction with NO (R4). The fraction of HO₂ (C_{HO_2}) converted into OH is measured during calibration experiments. When NO is added to the sampled air stream, the sum (background+net OH+net HO₂) is measured. The net HO₂ signal (S_{HO_2}) is derived from the subtraction between the net OH signal with NO added and the net OH signal without NO.

The radical concentrations are calculated by inverting Eqs. (1) and (2):

$$S_{\text{OH}} = [\text{OH}] \times R_{\text{OH}} \times P_w \quad (1)$$

$$S_{\text{HO}_2} = [\text{HO}_2] \times R_{\text{HO}_2} \times P_w \quad (2)$$

Calculating HO_x concentrations requires the measurement of S_{OH} , S_{HO_2} and the laser power P_w . It also requires the calibration of the detector response towards OH (R_{OH}) and HO₂ (R_{HO_2}) which are discussed in the calibration section. R_{OH} represent the number of photon counts per second produced per OH radical and normalized to 1-mW of laser power. The detector response towards HO₂ (R_{HO_2}) is the product of R_{OH} and the fraction of HO₂ converted into OH (C_{HO_2}) prior the detection axis ($R_{\text{HO}_2} = R_{\text{OH}} \times C_{\text{HO}_2}$).

The instrumental stability is largely governed by the stability of the laser intensity. Slow drifts are tracked during measurements by monitoring the laser power at the exit of both the dye laser (UV_{dye}) and the white cell (UV_{cell}). The ratio UV_{cell}/UV_{dye} is used to track the transmission of the laser light through the optical fiber and the cleanliness of the optics inside the white cell.

2.6 Instrument calibration

The accuracy of in situ measurements of OH and HO₂ radicals in the atmosphere is critically dependent on the accuracy of the calibration factor and the potential changes which

may occur during field measurements. The sensitivity towards OH depends on the excitation rate (ER) of OH in the rotational level being probed, on the fluorescence yield (FY) of the OH excited state and on the collection efficiency (CE) of the resulting fluorescence (Stevens et al., 1994; Holland et al., 1995; Kanaya et al., 2001):

$$R_{\text{OH}} = f[\text{ER}(L, \nu, \Delta\nu_{\text{D}}, \Delta\nu_{\text{L}}, P_w, P_{\text{cell}}, P_{\text{amb}}, T), \text{FY}(\tau_{\text{rad}}, k_{q_i}, [M_i]), \text{CE}(\Omega, T_v, \eta_v, f)] \quad (3)$$

The excitation rate (ER) represents how many OH radicals are promoted to the excited state per unit of time. This term is a function of the length of the laser beam overlapping the ambient air stream, L , the operating wavelength, ν , the full widths at half maxima of the molecular (Doppler, $\Delta\nu_{\text{D}}$) and laser ($\Delta\nu_{\text{L}}$) lineshapes, the averaged laser power, P_w , the pressure inside and outside the sampling cell, P_{cell} and P_{amb} , and the rotational temperature at the detection axis, T . The collection efficiency (CE) represents the fraction of fluorescence collected by the optical train and recorded by the photon counting system. This term depends on the solid angle imaged on the detector, Ω , the transmittance of the optics, T_v , the quantum efficiency of the MCP, η_v , and the fraction of the pulses emitted during the counting gate period, f . With the exception of average laser power, both the excitation rate and the collection efficiency depend on parameters that are kept under control and do not vary during field measurements, except the excitation rate which depends linearly on the averaged laser power. However, simultaneous monitoring of the laser power during HO_x measurements allows tracking the excitation rate (ER) and thus R_{OH} .

The fluorescence efficiency (FE) is the ratio of the total lifetime of the OH excited state, τ , and the natural radiative lifetime, τ_{rad} :

$$\text{FE} = \frac{\tau}{\tau_{\text{rad}}} \quad (4)$$

The total lifetime depends on τ_{rad} and on the collisional deactivations due to the species q_i which quench electronically excited OH by inelastic scattering at a rate k_{q_i} :

$$(\tau)^{-1} = (\tau_{\text{rad}})^{-1} + \sum_i k_{q_i} [q_i] \quad (5)$$

The fluorescence yield, and thus R_{OH} , depends on the operating pressure and the chemical composition of the sampled air mass. The most efficient quenchers of the OH excited state in ambient air are N₂, O₂ and H₂O. Constant atmospheric O₂ and N₂ mixing ratios as well as the negligible variation of the internal pressure under normal operating conditions do not cause variation of the quenching rates. However, the water mixing ratio is highly variable in the troposphere (1–3%) and care must be taken to calibrate the dependence of R_{OH} toward the water concentration. During field measurements, simultaneous monitoring of absolute humidity allows correction of R_{OH} for the quenching of the fluorescence yield from water-vapor.

The calibration procedures employed to measure R_{OH} and R_{HO_2} have been described in details elsewhere (Dusanter et al., 2008) and only information relevant to the HO_x calibration for MCMA-2006 are given here. Calibrations were performed using two techniques based on fundamentally different approaches. Calibrations using the steady-state O₃-alkene technique were done before, during and after the MCMA campaign, while calibrations using the water-vapor UV-photolysis technique were done after the MCMA campaign.

The O₃-alkene technique relies on the production of a steady-state concentration of OH during the ozonolysis of trans-2-butene in a flow tube at atmospheric pressure. During a calibration, S_{OH} is measured at various alkene concentrations for a constant ozone concentration. R_{OH} is inferred from its relationship with the intercept of a linear regression between $1/S_{\text{OH}}$ and $1/[\text{trans-2-butene}]$ and the values of the rate constants involved in the OH steady-state calculation (Hard et al., 2002; Dusanter et al., 2008). The water-vapor UV-photolysis technique takes advantage of the photolysis of water-vapor at 184.9-nm in a calibrator at atmospheric pressure. The water-vapor photolysis leads to the production of an equal amount of OH and HO₂ radicals. The concentration of OH radicals is determined using O₂ actinometry to derive the lamp flux and the photolysis time (Dusanter et al., 2008). Inside the calibrator, OH and HO₂ radicals can be lost through self- and cross-reactions and on the wall of the calibrator. The loss of each radical is measured during the calibration procedure and the calculated concentrations are corrected to reflect the concentration of radicals entering the instrument (Dusanter et al., 2008).

The sensitivities derived from the steady-state O₃-alkene technique were found to be consistently lower than that derived from the water-vapor UV-photolysis technique by approximately 40%. Although this difference is within the experimental uncertainties of the techniques, there are a number of possible explanations for this difference (Dusanter et al., 2008). A likely reason for the discrepancy between the techniques is a systematic error associated with the O₃-alkene calibration technique which may be the result of an OH production time-scale that is different between the calibration experiments (140–210 ms) and the scavenger experiments used to derive OH yields from O₃-alkene reactions (a few minutes to hours) (Atkinson and Aschmann, 1993; Fenske et al., 2000; Kroll et al., 2001b). The OH yields published in the literature, measured at long reaction times, may be higher than the OH yield produced in the calibration system at short reaction times (Kroll et al., 2001a). As a result, using the reported OH yield may lead to an underestimation of R_{OH} . Because of the uncertain O₃-alkene chemistry and the time dependence of the OH yield, only calibrations performed with the water-vapor UV-photolysis technique were used to derive R_{OH} for the IU-FAGE instrument (Dusanter et al., 2008).

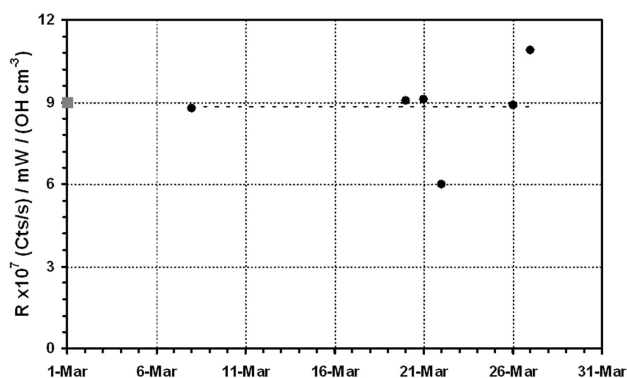

Fig. 4. The black circles represent the calibration performed during the MCMA-2006 field campaign using the O₃-alkene calibration technique described in Dusanter et al. (2008). The grey square plotted on 1st March represents the average value for calibrations performed during laboratory tests prior to MCMA-2006.

Prior to the MCMA-2006 field campaign, laboratory calibrations performed with a 2-m long optical fiber using the O₃-alkene calibration technique led to a measured R_{OH} of 2.1×10^{-6} cts/s/cm⁻³/mW in dry air. Similar calibrations were performed using a 12-m long fiber and led to a measured R_{OH} of 9.0×10^{-7} cts/s/cm⁻³/mW in dry air, which is approximately 2.3 times lower than that obtained from the shorter fiber. This difference is due to a lower transmittance of the laser light through the longer fiber and the use of a delayed counting gate to avoid background scatter due to reflection of the laser off the ends of the fiber (see above).

During the MCMA-2006 campaign, the IU-FAGE instrument was set-up with the 12-m long optical fiber and calibrated using the O₃-alkene technique. Figure 4 displays six field calibrations and shows the stability of R_{OH} throughout the campaign. The averaged sensitivity measured using this calibration technique was $R_{OH} = 8.8 \times 10^{-7}$ cts/s/cm⁻³/mW in dry air, similar to the calibrations performed before the campaign. This value of R_{OH} for the MCMA-2006 campaign was then corrected to account for the systematic difference of 40% observed between the water-vapor UV-photolysis technique and the steady-state O₃-alkene technique. R_{OH} was also corrected for its water-dependence using additional calibrations performed after the campaign (Dusanter et al., 2008). Uncertainties in R_{OH} and R_{HO_2} from the water-vapor UV-photolysis calibration technique are respectively 17% and 18% (Dusanter et al., 2008), while the precision in the measurements of R_{OH} using the O₃-alkene technique is 7%. Assuming an additional error of 10% to correct for the systematic difference between the calibration techniques and a propagation of errors in quadrature, the uncertainties on R_{OH} and R_{HO_2} for the MCMA campaign are respectively 21% and 22%.

2.7 Specificity of the HO_x measurements

Spectral interferences in the measured OH signal may be caused by other fluorescing species, which can be excited and detected around 308-nm. Only species exhibiting a resolved excitation spectrum can interfere with HO_x measurements due to the fine rotational structure of OH and the on/off-resonance procedure used to derive S_{OH} . The fluorescence generated by species that exhibit broad absorption features is discriminated from the OH fluorescence during the measurement sequence when the laser wavelength is adjusted on- and off-resonance with the narrow OH spectral line. The same amount of spurious fluorescence is recorded during on- and off-measurements and potential interferences are automatically subtracted when the net OH signal is derived. However, chemical species such as naphthalene and formaldehyde exhibit resolved excitation spectra near 308 nm and may interfere with OH measurements. Naphthalene was recently observed to interfere during background measurements when the Q₁(2) transition of OH is employed (Ren et al., 2004). However, published naphthalene excitation spectra around Q₁(2) and Q₁(3) show that Q₁(3) is free of interferences (Martinez et al., 2004). Ren et al. (2004) investigated potential spectral interferences on the Ground-based Tropospheric Hydrogen Oxides Sensor (GTHOS), developed at Pennsylvania State University (Stevens et al., 1994; Mather et al., 1997; Faloon et al., 2004), and concluded that formaldehyde does not interfere for OH measurements using the Q₁(2) transition. It is worth noting that the instrumental response to formaldehyde may be somewhat different for the Q₁(3) transition. To our knowledge, no other spectral interferences have been reported in the literature for the resonant detection scheme of OH at 308 nm. In the future, instrumental tests will be performed during field measurements to investigate whether potential spectral interferences are present. The spectral properties of the fluorescing species, excitation spectrum and lifetime of the excited state, will be monitored using an automated sequence. The recorded parameters will be compared to that expected for the OH radical to provide quantitative evidence that the detected signal arises solely from the OH radical. Unfortunately, the sensitivity of the instrument prevented implementation of these tests during the MCMA-2006 field campaign.

Additional interferences with measurements of ambient OH radicals can arise from OH radicals generated in the low-pressure region of the FAGE apparatus. Chemical species that absorb the laser light during measurements may decompose and produce OH directly (HONO → OH + NO for example) and indirectly (the O₃-water interference mentioned above). This artificial OH is then detected within the same laser pulse that produced it. Ren et al. (2004) investigated potential photolytic interferences from HONO (up to 5 ppb), H₂O₂ (up to 120 ppb), HNO₃ (up to 50 ppb) and acetone (up to 200 ppm) on the GTHOS instrument and concluded that none of these species were able to generate significant

interferences. Note that the concentrations used during those tests were higher than that observed during MCMA-2006.

Photolytic production of OH can be investigated during field measurements using two different on-line tests: (i) In contrast to the detection of ambient OH, which is a one photon process, the detection of laser-generated OH requires two photons to successively produce and detect an OH molecule. Providing that the OH absorption transition is not saturated, the one-photon process will exhibit a linear dependence with the averaged laser power. In addition, providing that the absorption transition of the interfering species is not saturated, the two-photon process will exhibit a quadratic dependence for a direct production of OH (such as $\text{HONO} \rightarrow \text{OH} + \text{NO}$). If OH is generated during complex kinetics involving competing secondary reactions at the detection axis, a scaling exponent different than 2 may be observed. In order to determine whether laser-generated OH is produced in the detection region, the OH concentration is successively measured at various laser powers, assuming that ambient OH concentrations do not vary significantly between the measurements. (ii) A second test is based on chemical modulation of OH by adding a scavenger (C_3F_6) during the sampling stage (Dubey et al., 1996). The scavenger concentration is adjusted to remove ambient OH prior to the air sample reaching the detection region. Laser-generated OH produced and detected within the same laser pulse will not be removed efficiently due to the short reaction time and can be easily identified.

Thermal decomposition of an unstable species inside the low-pressure cell may also produce OH. A possible example is the unimolecular decomposition of Criegee intermediates produced from the reaction of O_3 with alkenes, producing OH radicals at low pressure (Kroll et al., 2001a). This spurious OH would exhibit a linear dependence with the laser power. As a result this interference can not be detected by changes in the laser intensity. However, a change in the chemical modulation efficiency could indicate the production of OH from a non-photolytic source. The chemical modulation efficiency can be defined as one minus the ratio between the OH signal remaining after reaction with the chemical reagent and the OH signal monitored without reagent flowing. The chemical modulation efficiency depends on instrumental parameters such as the concentration of the chemical reagent (C_3F_6) inside the sampling cell, the internal pressure and the transit time between the sampling point and the detection zone. This parameter can be characterized under the working conditions of the FAGE apparatus for various concentrations of reagent using an interference-free source of OH radicals such as the photolysis of water-vapor. During ambient measurements, if OH is produced in the sampling cell by decomposition of unstable species, the chemical modulation efficiency should appear lower than that observed during laboratory measurements.

The IU-FAGE instrument was equipped with the chemical modulation test before the MCMA campaign, with addition of C_3F_6 through the same injector used for NO injec-

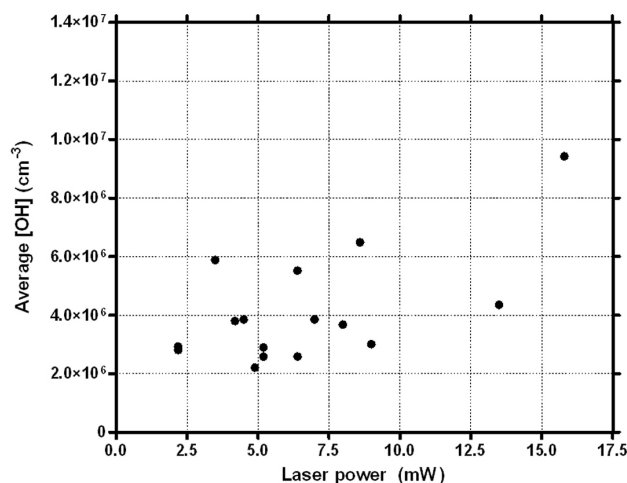

Fig. 5. Average OH concentrations (10:00 a.m. to 05:00 p.m.) measured between 14 and 31 March as a function of the average laser power.

tion. However, difficulties associated with the NO injection system during the campaign required disabling the C_3F_6 injection system. The absence of this automated test makes it difficult to rule out interferences during the MCMA campaign. However, several points suggest that the level of such interferences were low compared to ambient OH concentrations: (i) The IU-FAGE instrument is based on a similar design to GTHOS (Faloona et al., 2004), which was deployed in a similar polluted environment without interference issues during MCMA-2003 (Shirley et al., 2006). In addition, the IU-FAGE instrument uses a lower laser power than GTHOS to detect OH, suggesting lower potential photolytic interferences. (ii) Tests performed before the MCMA-2006 campaign (including C_3F_6 tests on ambient measurements) suggest that the IU-FAGE instrument was free of photolytic interferences. (iii) Over the course of the campaign, the laser power decreased from 15.8 to 2.2-mW. If a laser generated interference was present, it would be expected that its contribution to the OH signal would decrease by a factor of approximately 50 during the campaign. However, measured OH concentrations did not exhibit a significant trend as the laser power decreased (Fig. 5), strongly suggesting that the measurements are free of photolytic interferences.

Potential interferences can be investigated during inter-comparison studies involving instruments based on different techniques. Unfortunately, there have been relatively few inter-comparisons of OH measurement techniques (Heard and Pilling, 2003). These inter-comparisons have involved DOAS, CIMS and FAGE instruments, and show relatively good agreement (Heard and Pilling, 2003; Dusanter et al., 2008). These studies give confidence regarding the low level of interferences of the FAGE technique.

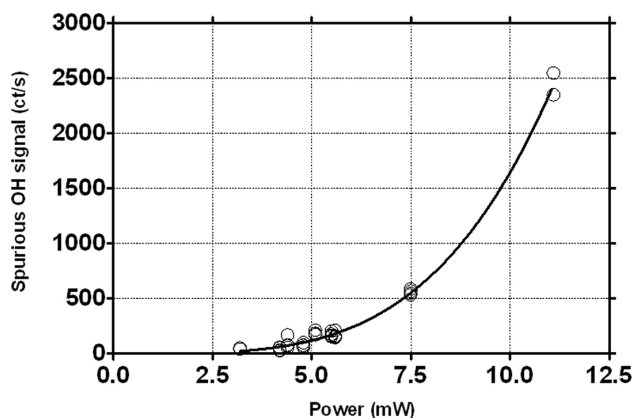

Fig. 6. Calibration of the spurious OH produced during HO₂ measurements in clean air. S_{OH} was measured at various laser power and various NO flows during the MCMA-2006 field campaign. S_{OH} was found to be linear with NO and was therefore normalized to 1 SCCM of NO. The circles display all the measurements performed on nine different days during the campaign. The black line is a non-linear fit of the measurements using a power function.

Hydroperoxy radical measurements using FAGE are based on the rapid gas-phase titration of HO₂ by nitric oxide, which produces one molecule of OH per molecule of HO₂ reduced. The amount of OH produced during the titration step is then quantified by laser-induced fluorescence. As a consequence of the addition of high amounts of NO inside the sampling cell, secondary chemistry may lead to the production of spurious OH. These secondary reactions include the laser-photolysis of impurities present in the NO mixture and laser-photolysis of chemical species produced in the sampling cell. Artificial OH may also be generated by bimolecular reactions involving NO. Note that photo or thermal decomposition of chemical species formed in the atmosphere is unlikely to produce interferences during HO₂ measurements. If such interferences were present, their impact would be observed during OH measurements. Since HO₂ concentrations are generally much higher than OH (10 to 100 times), an interference observed at the ambient OH level would be insignificant at the ambient HO₂ level.

Tests performed during MCMA-2006 indicated that an interference was present during HO₂ measurements due to the addition of NO inside the sampling cell. We observed a signal showing a power dependence with the laser power and a linear dependence with the NO concentration, characteristic of a multi-photon process. This interference, probably caused by photolysis of unknown impurities in the NO mixture, has not been identified but was quantified during the MCMA campaign by performing zero-air tests. A flow-tube was attached to the sampling nozzle and the laser-generated OH was measured in clean air with NO flowing through the injector. Tests performed showed an excellent linearity between the detected signal and the NO flow. The net sig-

nal was normalized to 1-SCCM of NO and plotted against the laser power as shown in Fig. 6. The signal exhibits a clear dependence on the laser power, characterized by an exponent of 3.80 ± 0.07 (1σ , $N=36$ values). The exponential factor is higher than the expected quadratic dependence on laser power due to a two-photon process such as the O₃-water interference, and is likely the result of complex kinetics involving competing secondary reactions in the detection zone. Further laboratory tests will be performed to resolve this issue. However, the calibration curve shown in Fig. 6 allows quantification of the OH interference produced during HO₂ measurements, and this curve was used to correct the net HO₂ signal measured during the MCMA campaign. Corrections were in the range 5–60% on a daily average with the highest impact for days when HO₂ concentrations were low and a high laser power was used. In general, this correction was usually below 35%. The additional error due to this interference was included in the estimates of the precision of the HO₂ measurement.

Other potential interferences during tropospheric HO₂ measurements have been discussed in several publications (Stevens et al., 1994; Hard et al., 1995; Faloon et al., 2000; Martinez et al., 2003; Ren et al., 2004; Ren et al., 2006; Kanaya et al., 2007). One potential interference involves the conversion of ambient organic peroxy radicals (RO₂) to HO₂ inside the sampling cell. RO₂ radicals can react with NO leading to the production of HO₂ through a two-step mechanism (R5, R6):



The chemical reaction between RO₂ and NO leads to the formation of alkoxy radicals (RO), which can decompose and/or react with oxygen to produce HO₂. However, numerical simulations (Stevens et al., 1994) and laboratory characterization (Ren et al., 2004) have shown that the rate of HO₂ formation from RO+O₂ is too slow under the reduced pressure conditions inside the FAGE cell to generate significant concentrations of HO₂ from ambient RO₂. Interference levels lower than 2% have been characterized by these authors.

Another potential interference involves thermal dissociation of peroxyxynitric acid (HO₂NO₂) and others peroxyxynitrates leading to the production of HO₂ radicals in the sampling cell. Previous studies have found that this type of interference is negligible under polluted conditions (100 ppb of NO₂) (Hard et al., 1995). In addition, thermal dissociation of HO₂NO₂ in a FAGE instrument was found to be negligible during aircraft measurements (Faloon et al., 2000). Production of OH from a chemical reaction between HO₂NO₂ and NO was recently proposed as another potential HO_x interference (Kanaya et al., 2007). The authors argued that a conversion of 1% of HO₂NO₂ to OH would be enough to double the measured HO₂ signal since the HO₂NO₂/HO₂ ratio was as

high as 100 during the IMPACT IV field campaign. On a median basis for MCMA-2006 between 08:40 and noon, measured HO₂ concentrations ranged from 6.5 to 13 × 10⁷ cm⁻³ while model estimated concentrations of HO₂NO₂ are in the range 5–10 × 10⁸ cm⁻³ (Dusanter et al., 2009). Assuming a model-calculated [HO₂NO₂] at noon of approximately 2 × 10⁹ cm⁻³, a HO₂NO₂-to-OH conversion of 1% would lead to an estimated interference of 2 × 10⁷ cm⁻³, approximately 10% of the observed median HO₂ concentration measured at noon. A conversion efficiency of 3% would lead to an estimated interference of 6 × 10⁷ cm⁻³, which could account for 30% of the observed HO₂ signal. Although there have been no reported measurements of a reaction that converts peroxy nitrates to OH under high NO_x conditions, additional studies are required to address this potential interference.

Intercomparison studies involving instruments based on different techniques for the measurement of HO₂ are sparse. HO₂ measurements were performed simultaneously by a FAGE and a MI-ESR (Matrix Isolation-Electron Spin Resonance) instruments during the BERLIOZ field campaign (Platt et al., 2002). A linear regression of the FAGE measurements vs. the MI-ESR measurements exhibits a slope of 1.03 ± 0.08 and an intercept of 0.15 ± 0.47 ($R^2=0.94$). Note that NO_x concentrations were in the range 2–16 ppb. An intercomparison between a FAGE and a CIMS instruments was performed at a rural site in Pennsylvania (Ren et al., 2003a) where ambient HO₂ concentrations were measured for 4 days under NO_x concentrations ranging from 4 to 7 ppb. A linear regression of the measured HO₂ concentrations resulted in a slope of 0.96 and a statically insignificant intercept of 0.60 ppt ($R^2=0.85$). Recently, a FAGE instrument modified to measure RO₂+HO₂ was compared to a MI-ESR instrument measuring the sum of peroxy radicals in the atmospheric simulation chamber SAPHIR (Fuchs et al., 2008). An excellent agreement was observed between the two techniques under low levels of NO_x. The three intercomparison studies mentioned above give confidence in ambient measurements of HO₂ using the FAGE instruments deployed in the field.

2.8 Instrument performance

The overall performance of IU-FAGE in terms of precision and limit of detection depends on the calibrated sensitivity, the stability of the laser power, and the various sources of noise that contribute to the background signal. The latter is detected in absence of OH fluorescence and is a combination of dark noise, electronic noise, and scattered photons from solar light and the laser beam. Dark noise is inherent to the detector and its contribution to the background signal is negligible. Electronic noise was reduced by careful design of the detection system and its contribution does not limit the performances of IU-FAGE. Prompt scattering of the excitation photons is the primary component of the background signal

that deteriorates the detection limit of OH. Scattered Photons from gaseous molecules (Rayleigh), particles (Mie) and reflections on the wall of the sampling cell are minimized by working at low pressure, careful baffling of the laser path, anodized inner surfaces and a gated detection system.

Instrument performance can be expressed using three quantities: the measurement precision, the detection limit and the total uncertainty. The precision is governed by rapid variations of the background signal due to laser power fluctuations, changes in Rayleigh and Mie scattering efficiency, and changes in solar scattered light. The precision, σ_p , is defined by the standard deviation of the background signal integrated during t seconds at N samples/second:

$$\sigma_p = \frac{\sqrt{2}\sigma_{\text{bkg}}}{\sqrt{Nt}} \quad (6)$$

Equation (6) assumes that the number of points acquired ($N \times t$) is similar for the on-resonance and the off-resonance signals as shown by the factor of 2^{1/2}. Using photon counting techniques, the standard deviation of the background signal follows a Poisson distribution and σ_{bkg} is equal to the square root of the background signal. However, investigations of the IU-FAGE background signal have shown that its distribution does not follow Poisson statistics. Figure 7 shows two segments of data taken during laboratory and field measurements, and shows that the background signal distribution is better represented by a Normal distribution. The reason for this is likely the result of normal-distributed fluctuations from rapid variations of the laser power and the scattering efficiency of the sampled air mass when the background signal distribution is investigated on a long time period. As a consequence, the precision of our measurements for the MCMA campaign was calculated using Normal statistics. It is worth noting that using a Poisson distribution would improve the measurement precision but would lead to an obvious underestimation of the measurement error.

The detection limit is the lowest OH concentration required to observe a net OH signal that is above the precision for a given signal to noise ratio (SNR):

$$[\text{OH}]_{\text{min}} = \text{SNR} \times \frac{\sigma_p}{R_{\text{OH}} P_w} \quad (7)$$

The total uncertainty for an OH measurement depends on the precision (σ_p), the uncertainty of the calibrated sensitivity R_{OH} , the uncertainty of the R_{OH} water-dependence and the uncertainties of the measured ambient water mixing ratios and laser power. Laboratory characterizations performed before the MCMA campaign shown that the IU-FAGE instrument, set-up with the 12-m long fiber, is capable of detecting 3.9 × 10⁵ molecule/cm³ at a signal to noise ratio of 1, an averaged laser power of 10-mW and a signal integration time of 5-min (on-resonance+off-resonance measurements). The calibration accuracies (1σ) are ±17% for OH and ±18% for HO₂ using the water photolysis calibration technique. However, during the MCMA-2006 campaign, the

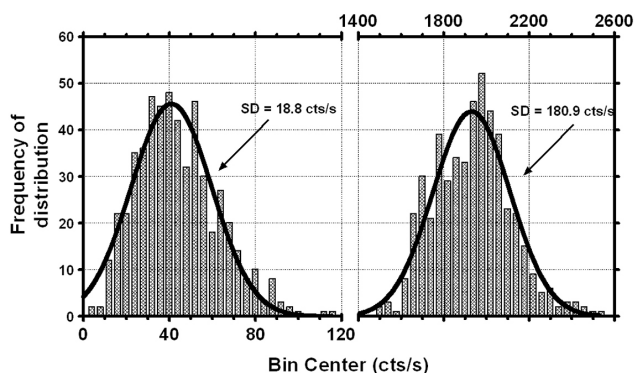

Fig. 7. Distribution of the background signal. The left portion of the figure represent the distribution of the background signal (537 points, bin width of 4 cts/s) observed during calibration experiment performed at a laser power of 3.6 mW. The right portion displays a similar distribution (502 points, bin width of 40 cts/s) observed on 27 March during the MCMA-2006 at a laser power of 4.0 mW.

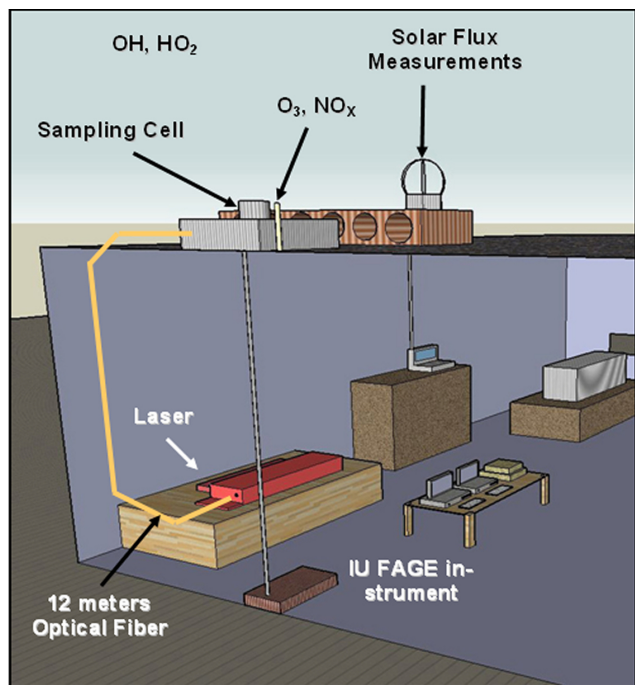

Fig. 8. Configuration of the IU-FAGE instrument during the MCMA 2006 field campaign.

IU-FAGE instrument was prone to a large, unknown electronic noise which deteriorated the instrument performance. The observed minimum detectable concentration displayed in Table 2 varied from 6.9×10^5 to 3.3×10^6 molecule/cm³ for a laser power ranging between 15 and 2 mW and an integration time of 7.5 to 30-min. Improved shielding and grounding of the detection system will be employed for future field deployments to reduce this interference.

3 Deployment of IU-FAGE during MCMA-2006

The Mexico City Metropolitan Area 2006 (MCMA-2006) field campaign was one of four components of MILAGRO (Megacity Initiative: Local And Global Research Observations) intended to collect scientific information on the impact of megacity emissions on local, regional and global scales. The Mexico City Metropolitan Area was chosen as a case study for several reasons. Mexico City is the second largest megacity in the world and is characterized by high emissions of VOCs and NO_x. Mexico City lies at a sub-tropical latitude and an elevated altitude of 2240-m, resulting in an active photochemical environment. As a result, chemical processing of the primary pollutants in the MCMA basin gives rise to secondary pollutants such as O₃, whose concentration exceed air quality standards more than 300 days a year (Raga and Raga, 2000; Molina and Molina, 2002). More information about recent MCMA field studies can be found in Molina et al. (2007) and references therein.

Only details pertinent to the HO_x measurements performed by the IU-FAGE instrument are given in the following sections. Qualitative observations are provided to help understand the behavior of HO_x concentrations in polluted environments. Comparisons between model-predicted and measured HO_x concentrations and an assessment of the radical budget during MCMA-2006 will be presented in a separate publication (Dusanter et al., 2009).

3.1 O₃, NO_x and J-values measurements

Measurements of radiative parameters and long-lived species, characterizing HO_x sources (photolysis rate constants, O₃, HCHO, CH₃CHO, HONO, CHOCHO, HNO₃), sinks (NO_x, SO₂, CO, VOCs), and meteorological parameters were measured at the Instituto Mexicano del Petroleo (T0 site). Only measurements pertinent for this study are briefly described below.

Measurements of O₃, NO_x and J-values were performed on the roof of the building 32 at T0, collocated to IU-FAGE. O₃ was monitored using a commercial monitor (Teledyne 400E) based on UV absorption whose calibration was performed against a photometric O₃ calibrator (API, M401) before and after the MCMA field campaign. Measurements of NO_x (Thermo Environmental) were performed using a commercial monitor from RAMA based on chemiluminescence of NO₂. Uncertainty and detection limits for 10-min average are 10% (1σ) and 0.1 ppb (1σ) respectively for O₃, NO and NO₂ measurements. Photolysis frequencies for NO₂ → NO + O(³P), O₃ → O(¹D) + O₂, HONO → HO + NO, HCHO → H + HCO and HCHO → H₂ + CO were directly measured using a spectroradiometer as described for MCMA-2003 (Volkamer et al., 2007). Uncertainties are estimated to be 25% for J(O¹D) and 15% for J(NO₂), J(HONO) and J(HCHO).

Table 2. Fractional amount of OH measurements higher than the limit of detection.

Day	Limit of detection Daily average ($\times 10^6 \text{ cm}^{-3}$)	Percentage of data-points higher than the limit of detection Signal/Noise=1	Averaging time (min)
14	0.98	95.7	7.5
15	0.69	100	7.5
16	0.79	85.3	15
17	0.83	85.7	30
18	2.1	77.8	30
19	1.3	92.9	30
20	1.5	75.0	30
21	2.6	74.4	30
22	1.9	80.0	30
23	1.8	83.3	30
25	3.2	42.9	30
26	1.9	55.6	30
27	1.8	37.5	30
28	3.3	52.6	30
29	2.9	58.8	30
30	1.2	82.0	30
31	1.5	83.3	30
14–31		79.4	

3.2 HO_x measurements

Atmospheric OH and HO₂ concentrations were measured between 14th and 31st March. The laser system and associated electronics were located inside an annex on the roof of Building 32 at T0 as shown in Fig. 8. The sampling cell was located on the roof of this annex and was set-up using the 12-m long optical fiber.

As mentioned in the Instrument performance section, the precision of the HO_x measurements during the campaign was degraded by electronic noise at this site, and an averaging time of 7–30 min was necessary to achieve a reasonable detection limit ranging from 6.9×10^5 to 3.3×10^6 molecule cm^{-3} at SNR=1 for OH. Table 2 shows that 79.4% of the data points recorded from 14 to 31 March are higher than the limit of detection (S/N=1). HO₂ concentrations were 10–100 times higher than OH and an averaging time of 15-s is sufficient to get a detection limit in the range 4.4×10^6 to 2.8×10^7 molecules cm^{-3} . OH and HO₂ were not measured simultaneously, as only one detection axis was used to measure both radicals. HO₂ was measured for 15-s

every 15-min (14–15 March) and every 8-min (16–31 March) and OH was measured during the remaining time using 10-s modulation cycles. The calibration accuracies (1σ) are 21% for OH and 22% for HO₂, taking into account the additional error introduced by the correction from the systematic difference observed between the steady-state O₃-alkene and the water-vapor UV-photolysis calibration techniques, as discussed in the Calibration section.

The time series of measured OH concentrations and its median profile for all measurements are displayed in Figs. 9–11, together with measured J(O¹D) values. These figures show that OH exhibits a diurnal pattern, which follows the solar actinic flux. The maximum OH concentration observed from day to day varied between 2.0×10^6 and 1.5×10^7 molecule cm^{-3} . On a median basis (Fig. 11), OH peaked near 4.6×10^6 molecule cm^{-3} at noon (CST). Note that high levels of OH (usually above 5×10^6 cm^{-3}) are clearly observed on 16th, 18th and 21st March between 09:30–11:00 a.m. (Fig. 9). This suggests that efficient HO_x sources and/or a fast radical propagation under the high NO_x conditions of the MCMA exist during the morning hours.

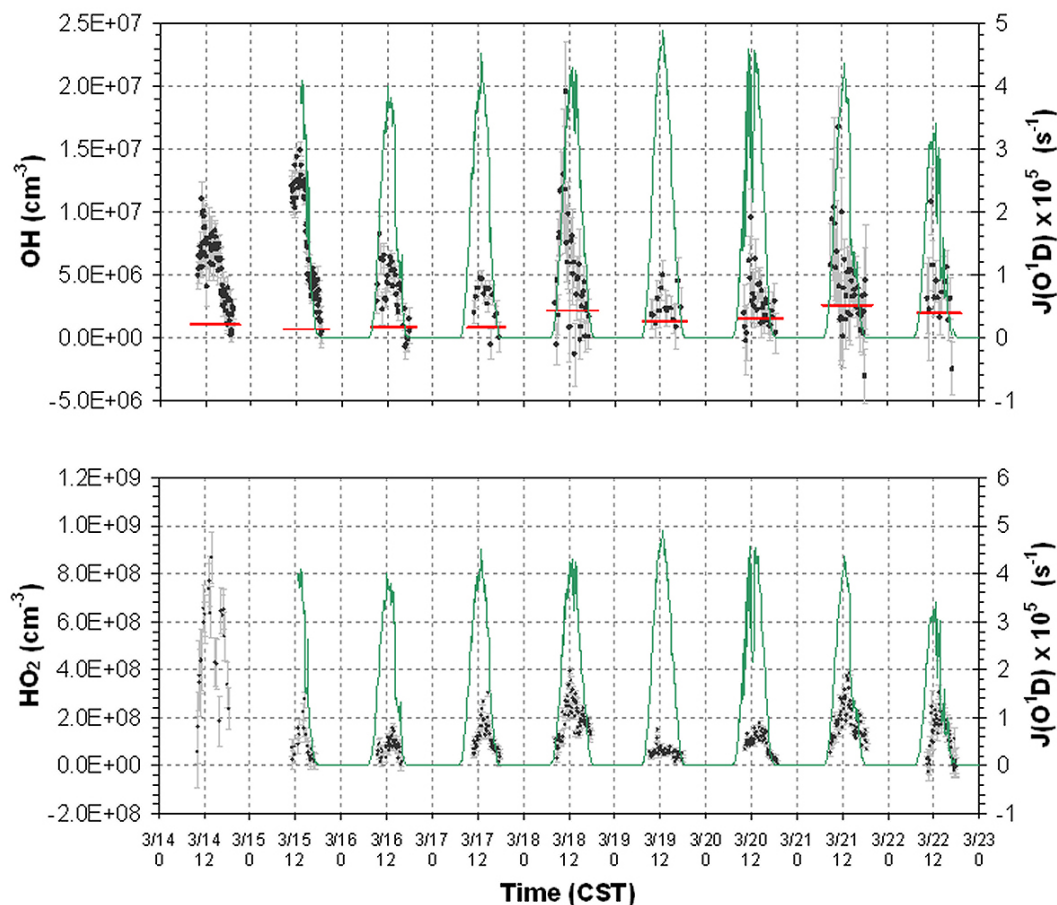

Fig. 9. OH and HO₂ diurnal profiles from 14 to 22 March. The upper panel displays the measured OH concentrations using black circles. The OH measurements are averaged for 7.5-min for 14 and 15 March, 15-min for 16 March, and 30-min for 17–22 March). The lower panel displays the measured HO₂ concentrations using black circles and an integration time of 15-s. For both panels, the green line corresponds to the measured J(O¹D) values, the red line displays the limit of detection (S/N=1) and grey error bars are the precision (1 σ) on the HO_x measurements.

This is consistent with the intense morning photochemistry observed during MCMA-2003 (Shirley et al., 2006; Volkamer et al., 2007). OH concentrations decrease with J(O¹D) in the late afternoon and remain at a significant level of $0.7\text{--}1.5 \times 10^6$ molecule cm⁻³ between 05:00 and 07:00 p.m. (CST). This may be the result of the HO₂ conversion into OH through its reaction with NO and/or the ozonolysis of unsaturated compounds which are known to yield OH, HO₂ and RO₂ radicals (Paulson and Orlando, 1996).

A time series and the median diurnal profile of the measured HO₂ concentrations are also displayed in Figs. 9–11. The dependence of HO₂ concentrations on the solar actinic flux is less evident than that for OH. The maximum daily HO₂ concentration ranged from 5.6×10^7 to 4.5×10^8 molecule cm⁻³. In addition, peak concentrations up to 6.5×10^8 molecule cm⁻³, were also observed on March 28th and 31st during morning hours. The diurnal median profile of HO₂ peaks at 1.9×10^8 molecule cm⁻³ and occurs

approximately one hour later than OH. The later peak of HO₂ in urban environments with respect to J(O¹D) has been observed previously in several studies and is likely related to high NO_x emissions during the morning rush-hour suppressing the production of HO₂ as well as O₃ (Holland et al., 2003; Martinez et al., 2003; Ren et al., 2003b; Shirley et al., 2006). Figure 12 also displays measurements of NO, NO₂ and O₃ sampled within 50–100 cm of the IU-FAGE nozzle. The median NO mixing ratio was more than 200 ppb around 07:00 a.m. and decreased slowly during the morning and early afternoon.

Photolysis of O₃ at short wavelengths and the subsequent reaction of the photoproduct O(¹D) with water-vapor (R1–R2) is the major source of RO_x (OH+HO₂+RO₂) radicals in the remote-rural troposphere and J(O¹D) can be considered as an indicator for the total photolytic production of odd hydrogen radicals. However, photolysis of other oxygenated species such as HONO, glyoxal, methylglyoxal and other

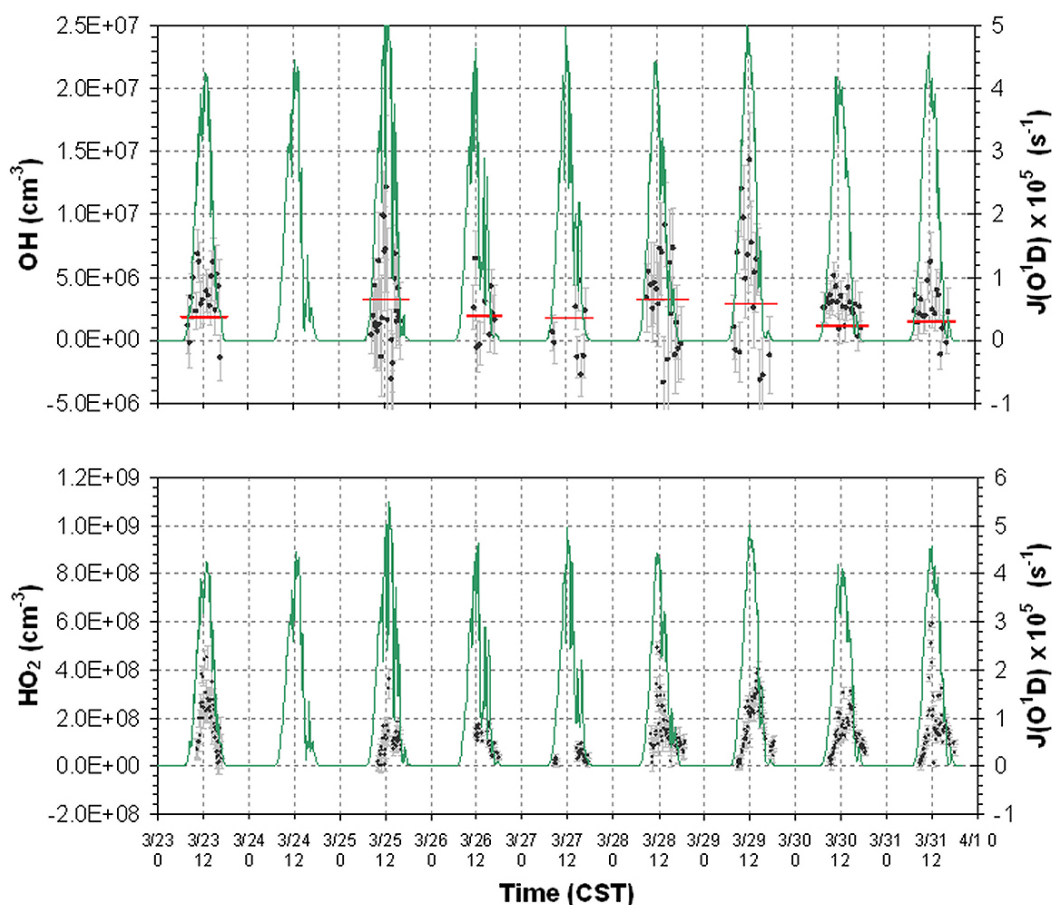

Fig. 10. OH and HO₂ diurnal profiles from 23 to 31 March. The upper panel displays the measured OH concentrations using black circles with an integration time of 30-min. The lower panel displays the measured HO₂ concentrations using black circles and an integration time of 15-s. For both panels, the green line corresponds to the measured J(O¹D) values, the red line displays the limit of detection (S/N=1) and grey error bars are the precision (1 σ) on the HO_x measurements.

dicarbonyl species can also contribute to the RO_x production in urban environments. The contribution of these species to the production of RO_x has been found to be important relative to O₃ photolysis in the MCMA (Volkamer et al., 2007). Note that like HONO, these species are photolysed at wavelengths longer than 330-nm, and as a result J(HONO) is expected to be a better proxy than J(O¹D) to describe the total photolytic production of RO_x in this environment. However, the observed correlation of the measured OH concentration with J(HONO) is not significantly better than the observed correlation between OH and J(O¹D). Figure 13 displays the correlation plots between measured OH and J(HONO) and J(O¹D) that illustrates the OH dependence on the photolytic production of radicals in MCMA-2006. The low correlation coefficient ($R^2=0.199$ for J(HONO), $R^2=0.163$ for J(O¹D))) indicates that less than 20% of the variance of OH can be explained by variations in J(HONO) or J(O¹D). A large part of this variance can be attributed to the OH measurement precision and to a lesser extent to the variability of the atmospheric

chemical composition (HONO, dicarbonyl species, O₃, NO) for similar J-values. Figure 13 also displays OH measurements performed under high and low NO_x conditions.

Under the high concentrations of NO_x observed during MCMA-2006, both OH and HO₂ are expected to decrease with increasing NO under conditions where the production rate of the radicals is constant (Martinez et al., 2003; Ren et al., 2003b). In the MCMA, the morning production of HO_x is mainly controlled by photolysis of HONO and to a smaller extent by photolysis of glyoxal, methyl glyoxal and unsaturated dicarbonyl species (Volkamer et al., 2007; Dusanter et al., 2009). However, in the MCMA, temporal variations of NO_x concentrations and J-values are not independent. High NO_x concentrations observed in the early morning are characterized by low J-values and low NO_x concentrations by higher J-values in the late morning-early afternoon. In order to investigate the HO_x/NO dependence, daily 30-min median OH and HO₂ concentrations were normalized to the 30-min median measurements of J(HONO) and [HONO] using

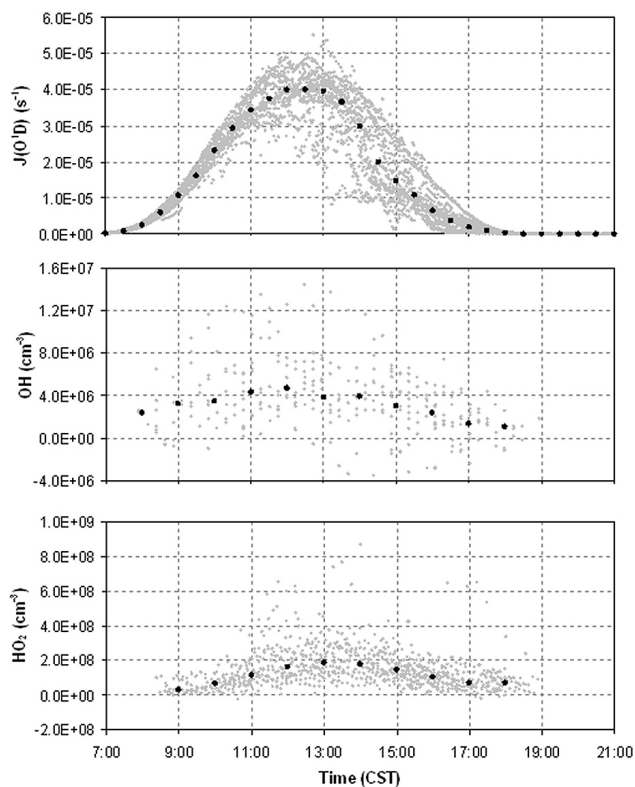

Fig. 11. Median $J(\text{O}^1\text{D})$, OH and HO_2 . Grey symbols are individual measurements and black symbols are the medians calculated on data binned with a time interval of 30-min for $J(\text{O}^1\text{D})$ and 60-min for OH and HO_2 . OH concentrations displayed on the middle panel were averaged for 30-min for each individual day. HO_2 concentrations displayed on the lower panel are individual measurements averaged for 15-s for each individual day.

Eq. (8). $J(\text{HONO})_{\text{avg}}$ and $[\text{HONO}]_{\text{avg}}$ are average values calculated from 08:30 a.m. to 06:30 p.m.

$$[\text{HO}_x]_{t,\text{normalized}} = [\text{HO}_x]_t \times \frac{J(\text{HONO})_{\text{avg}} \times [\text{HONO}]_{\text{avg}}}{J(\text{HONO})_t \times [\text{HONO}]_t} \quad (8)$$

$[\text{OH}]_{\text{normalized}}$ and $[\text{HO}_2]_{\text{normalized}}$ are plotted as a function of [NO] in Fig. 14. Only HO_x measurements performed at NO mixing ratios above 2 ppb are displayed in this figure. NO mixing ratios below 2 ppb were characteristic of measurements performed in the afternoon where other sources of HO_x , such as the photolysis of formaldehyde, cannot be normalized by $J(\text{HONO})$. As can be seen in Fig. 14, both OH and HO_2 decrease with increasing NO. A decrease of both, OH and HO_2 , is the expected qualitative behavior in a NO_x saturated environment. HO_2 decreases since NO shifts the partitioning of HO_x towards OH. OH also decreases as the result of an OH loss rate from $\text{OH}+\text{NO}_2$ that is higher than the OH production rate from HO_2+NO . However, the observed decrease in OH and HO_2 with increasing NO is not as steep as expected. This point will be discussed in a companion paper (Dusanter et al., 2009).

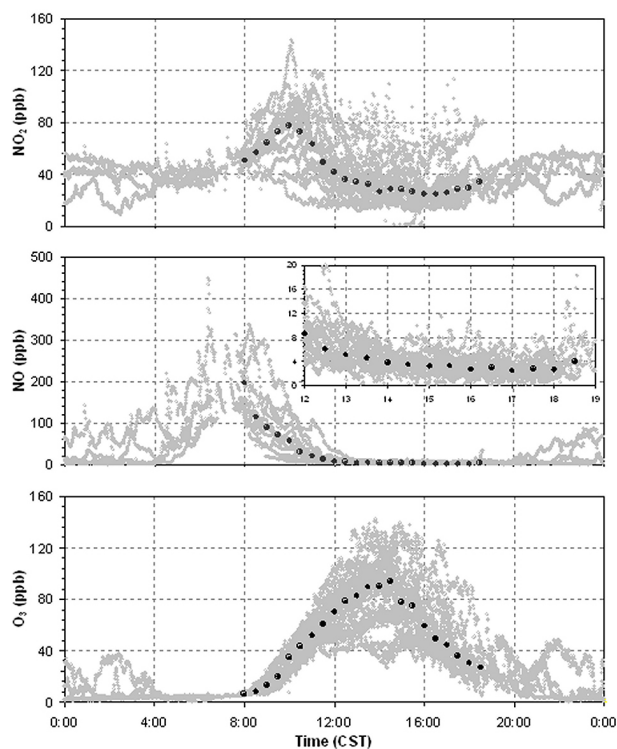

Fig. 12. Median NO, NO_2 and O_3 . Grey symbols are individual measurements averaged for 1-min and black symbols are the medians calculated on data binned with a time interval of 30-min. Day-time data between 08:00 a.m. and 06:00 p.m. were recorded from 14th March to 31st March. The remaining data was recorded between 26–31 March.

3.3 Comparison with previous urban measurements

Table 1 is a chronologic compilation of the field campaigns performed in urban and sub-urban environments that include HO_x measurements. Nine of the twelve studies were performed during spring-summer months, while only three studies focused on the photochemistry occurring in winter. Measurement-model comparisons have been performed using either comprehensive reaction mechanisms such as the Master Chemical Mechanism (MCM), or lumped chemical mechanisms such as the Regional Atmospheric Chemical Mechanism (RACM). Agreement between modeled and measured HO_x concentrations ranged between an underprediction by a factor of 2 for OH (PUMA) and 6 for HO_2 (PM-TACs winter campaign), and an overprediction by factors of 1.5–2 for OH (LAFRE, BERLIOZ) and 1.4 for HO_2 (BERLIOZ), with occasional agreement for both OH and HO_2 (MCMA-2003). It should be noted that the reported concentrations for MCMA-2003 have recently been revised and the new concentration profiles are approximately 1.6 times greater than previously reported (Mao et al., 2009).

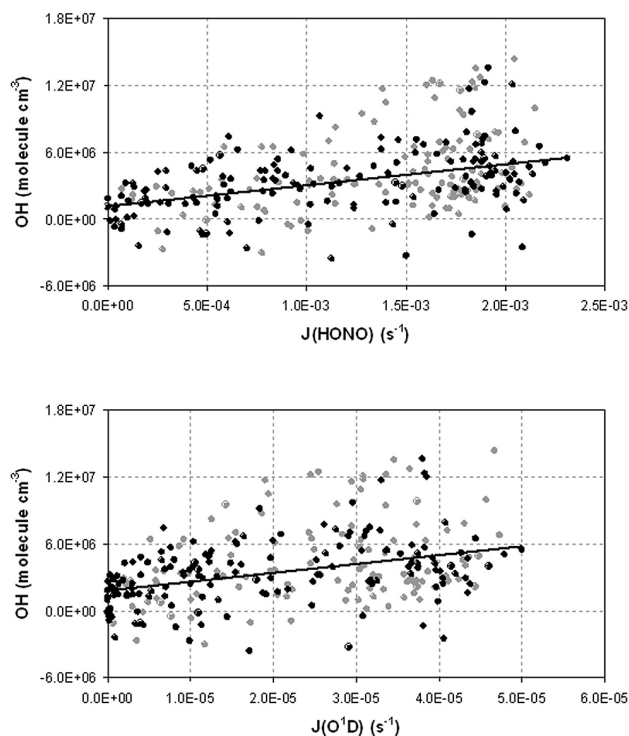

Fig. 13. Correlation plots between OH radicals, J(HONO) and J(O¹D). Daily measurements are averaged for 30-min over the whole campaign. The grey circles display measurements performed under high NO_x conditions before noon ($3.4 < \text{NO} < 292$ ppb, $15.8 < \text{NO}_2 < 127.1$ ppb). Black circles display measurements performed under lower NO_x conditions ($0.2 < \text{NO} < 13.5$ ppb, $0.7 < \text{NO}_2 < 77.1$).

This sparse agreement between measurement and model illustrates the difficulty in characterizing the complex HO_x chemistry of polluted environments.

Table 1 indicates that the production of HO_x radicals under polluted conditions is sometimes controlled by the photolysis of O₃ (BERLIOZ, SOS), as in remote environments. However, processes such as HONO photolysis (LAFRE, PM-TACs) and non-photolytic O₃-alkene reactions (PUMA) can also dominate HO_x production in urban environments. The wide variety of HO_x sources and sinks involved in urban environments makes it difficult to determine the radical budget in these areas. Table 1 indicates that OH measurements for the summer campaigns lay in a short range of concentrations from 2 to $9 \times 10^6 \text{ cm}^{-3}$, with the exception of PMTAC and SOS where OH concentrations as high as $20 \times 10^6 \text{ cm}^{-3}$ were observed on some days. It is interesting to note that high nighttime OH and HO₂ concentrations were also frequently observed during these two campaigns, in contrast to the other urban field measurements. This may suggest the contribution of additional HO_x sources for the latter two studies. This qualitative behavior suggests that the increased primary loss of OH, due to increasing NO_x and VOCs concentrations, is

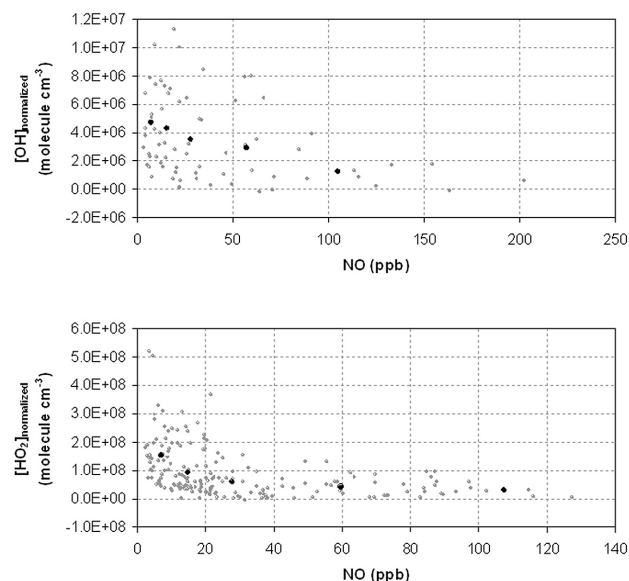

Fig. 14. Correlation plot between normalized HO_x concentrations and NO. 30-min median of daily OH and HO₂ concentrations are normalized to J(HONO) (see text). Grey circles display the measurements performed before noon. Black circles are medians based on binned NO.

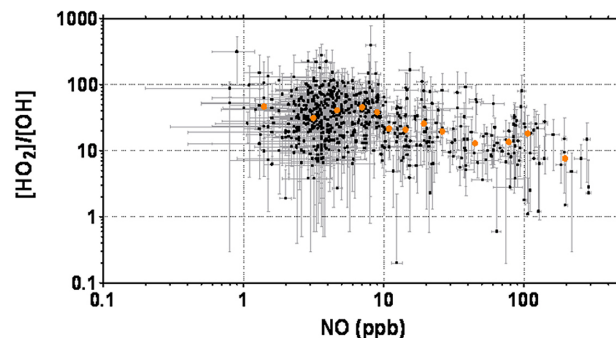

Fig. 15. Correlation plot between HO₂/OH ratio and NO. Black symbols are individual measurements and orange symbols are the median calculated on binned NO data.

often offset by higher secondary production rates of HO_x radicals due to photolytic reactions of oxygenated species, reactions between O₃ and alkenes and the production of OH from the rapid HO₂ conversion by NO.

The HO₂/OH ratio reflects the partitioning between OH and HO₂, which depends on the processes that interconvert the radicals. In contrast to absolute concentrations of HO_x, this ratio does not depend on the production and termination rates of the radicals. As a consequence, HO₂/OH is an interesting indicator of the cycling of RO_x (OH+HO₂+RO₂) radicals that can be used as a measure of the efficiency of radical propagation. Measured HO₂/OH ratios as a function of NO are displayed in Fig. 15. Note that OH and HO₂

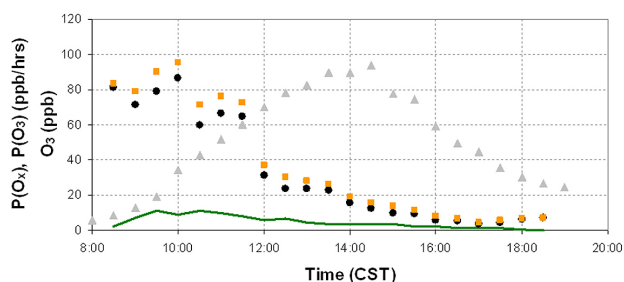

Fig. 16. Instantaneous production of O_x and O₃ from 14 to 31 March. Calculations were performed using Eq. (10) and Eq. (11) (see text). Orange squares display P(O_x) calculations using median measurements of HO₂ and NO. Black circles display P(O₃) calculations using median measurements of OH, HO₂, NO and NO₂. Grey circles are median measurements of surface ozone. The green line represents the chemical reaction rate of OH+NO→HNO₃.

were not measured simultaneously and for these calculations OH was averaged for 30-min around each HO₂ measurement (15-min before and after). HO₂/OH is expected to depend on NO_x and VOC concentrations and is expected to decrease with increasing NO because of the fast conversion of HO₂ into OH:

$$\frac{[\text{HO}_2]}{[\text{OH}]} \approx \frac{\sum \text{Rate of reactions (OH} \rightarrow \text{HO}_2)}{\sum \text{Rate of reactions (HO}_2 \rightarrow \text{OH)}} \approx$$

$$\frac{k_{\text{OH}+\text{VOC}}[\text{VOC}] + k_{\text{OH}+\text{CO}}[\text{CO}] + k_{\text{OH}+\text{O}_3}[\text{O}_3]}{k_{\text{HO}_2+\text{NO}}[\text{NO}] + k_{\text{HO}_2+\text{O}_3}[\text{O}_3]} \quad (9)$$

Observed HO₂/OH ratios varied from 1 to 120 during MCMA-2006, while measured NO mixing ratios were in the range 1–120 ppb for these calculations. These ratios are similar to that measured in previous campaigns (Table 1) and appear to decrease as NO increases. It is interesting to compare the results from MCMA-2003 and 2006 where the HO₂/OH ratios were measured in the same city, but at different locations and 3 years apart. The measured ratios during 2006 are generally smaller than that measured in 2003 for a similar NO mixing ratio (typical HO₂/OH ratios of 40 at 10 ppb of NO during MCMA-2003). This result is consistent with the lower concentrations of CO observed during 2006 (median peak CO of 2600 ppb in 2003 (Shirley et al., 2006) compared to a median 1600 ppb for CO in 2006), although the total level of VOCs was similar during the two campaigns (median peak of 1500 ppbc in 2003 (Shirley et al., 2006) compared to a median of 1600 ppbc for VOCs in 2006). However, median NO_x levels were generally 3 times lower in 2003 compared to 2006.

The gross rate of instantaneous O_x (O₃+NO₂) production, P(O_x) in Eq. (10), is driven by radical propagation and is also a good indicator of the cycling between OH and peroxy radicals:

$$P(\text{O}_x) = k_{\text{HO}_2+\text{NO}}[\text{HO}_2][\text{NO}] \quad (10)$$

$$+ \sum k_{\text{RO}_2+\text{NO}} \Phi_{\text{RO}+\text{NO}_2} [\text{RO}_2][\text{NO}]$$

In this equation, Φ_{RO₂+NO} represents the yield of RO+NO₂ from RO₂+NO. Figure 16 displays P(O_x) values calculated from 30-min median measurements of HO₂ and NO between 14 and 31 March. Note that these calculations only account for the NO-to-NO₂ oxidation rate due to HO₂, as they only use the first term on the right side of Eq. (10). For comparison with MCMA-2003, net instantaneous rate of O₃ production by HO₂ was also calculated using the formalism adopted by Shirley et al. (2006), using only the first and third terms in Eq. (11):

$$P(\text{O}_3) = k_{\text{HO}_2+\text{NO}}[\text{HO}_2][\text{NO}] \quad (11)$$

$$+ \sum k_{\text{RO}_2+\text{NO}} \Phi_{\text{RO}+\text{NO}_2} [\text{RO}_2][\text{NO}] \\ - k_{\text{OH}+\text{NO}_2} [\text{OH}][\text{NO}_2]$$

The difference between Eq. (10) and (11) is the subtraction of the HNO₃ production rate from OH+NO₂, done to account for the fraction of NO₂ formed that does not lead to O₃ production. However, note that using only OH, HO₂ and NO_x measurements in Eq. (11) likely leads to an underestimation of the O₃ production that can be attributed to HO₂ since the subtraction account for the NO₂ molecules formed during the oxidation of NO by all the peroxy radicals and not only HO₂. P(O_x) from Eq. (10) and P(O₃) from Eq. (11) display similar patterns and only P(O₃) is discussed below.

P(O₃) was as high as 80 ppb/h in the early morning (08:30–10:00 CST) and decreased to 31 ppb/h around noon, reaching a minimum of 3–4 ppb/h in the late afternoon (17:00–18:00 CST). The high P(O₃) values observed before solar noon are consistent with those observed in other urban environments (Martinez et al., 2003; Ren et al., 2003c; Shirley et al., 2006). P(O₃) values calculated for MCMA-2003 (Shirley et al., 2006) were about a factor of two lower than that for 2006. However, the agreement is better when using the revised HO_x dataset for MCMA-2003 (Mao et al., 2009). These P(O₃) values calculated for MCMA-2003 are similar to that calculated for MCMA-2006 from 08:00 to 12:00 CST while P(O₃) values for MCMA-2006 are a factor 2 lower from 12:00 to 18:00.

The instantaneous production of O₃ estimated from the HO₂ measurements described above appears to be inconsistent with the observed O₃ concentrations, and may suggest an interference with the measured concentrations of HO₂. However, while surface ozone concentrations [O₃] and instantaneous ozone production P(O₃) are strongly linked together, these two parameters are characterized by different temporal and spatial scales. Measured O₃ concentrations, which depend on the history of the air mass being sampled, reflect an integration of P(O₃) over a large spatial scale and a long timescale. The calculations of instantaneous ozone production presented here do not take these issues into account, which are critical in the conversion of P(O₃) into an amount of ozone eventually produced. In order to relate

measured surface O₃ concentrations and calculated instantaneous P(O₃), one may assume that P(O₃) is uniform throughout the MCMA. However, this assumption may be unrealistic since instantaneous P(O₃) is governed by local chemistry and may vary with the spatial and temporal distribution of NO_x, VOCs and HO_x sources and sinks over the MCMA. In addition, surface O₃ concentrations depend on physical and meteorological processes such as dry deposition, vertical and horizontal mixing and changes in the Planetary Boundary Layer (PBL) height. Clearly additional measurements are needed to resolve this issue.

4 Conclusions

A new instrument capable of measuring tropospheric OH and HO₂ concentrations by laser-induced fluorescence at low pressure has been developed and was deployed for the first time during the MCMA-2006 field campaign. Although experimental difficulties degraded the instrument's performance, diurnal concentration profiles of OH and HO₂ were successfully measured in Mexico City. At the present time, the minimum detectable OH is limited by the scattered laser light inside the sampling cell. Inorganic black coating and a lower internal pressure will be tested to improve the detection limit. In addition, the laser system and the propagation of the laser light will be optimized to increase the laser power inside the sampling cell. An on-line calibration system will be added to track potential daily variations of the instrument sensitivity during the day. Several automated tests will also be added in order to check for potential interferences during field measurements. First, measurements will be systematically performed as a function of laser power to test for laser generated OH. Second, measurements will be performed using both the Q₁(3) and the P₁(1) transition of OH to check for potential spectral interferences on a specific transition, in addition to an on-line analysis of the background signals acquired at different wavelengths. Third, measurements will be performed at various laser-repetition rates to check for potential recirculation and double-pulsing of the same air mass.

During the MCMA-2006 field campaign, maximum median OH and HO₂ concentrations were measured to be $4.6 \times 10^6 \text{ cm}^{-3}$ and $1.9 \times 10^8 \text{ cm}^{-3}$, respectively, during the day. These concentrations are consistent with previous measurements performed in other urban areas. A more detailed analysis of these results, including model comparisons, will be presented in a companion paper.

Acknowledgements. The authors are grateful to Xinrong Ren and William Brune for their help during the development of IU-FAGE. The authors also gratefully acknowledge the Molina Center for Energy and the Environment, Gustavo Sosa and the Instituto Mexicano del Petroleo for their help during the MCMA field campaign, and Rafael Ramos of RAMA for the use of one of their NO_x instruments. This research is supported by grants from the National Science Foundation (ATM-9984152 and 0612738) and the Camille and Henry Dreyfus Foundation.

Edited by: S. Madronich

References

- Atkinson, R. and Aschmann, S. M.: OH radical production from the gas-phase reactions of O₃ with a series of alkenes under atmospheric conditions, *Environ. Sci. Technol.*, 27, 1357–1363, 1993.
- Bailey, A. E., Heard, D. E., Paul, P. H., and Pilling, M. J.: Collisional quenching of OH(A²Σ⁺, v'=0) by N₂, O₂ and CO₂ between 204 and 294 K. Implications for atmospheric measurements of OH by laser-induced fluorescence, *J. Chem. Soc., Faraday Trans.*, 93, 2915–2920, 1997.
- Clemmshaw, K. C.: A review of instrumentation and measurement techniques for ground-based and airborne field studies of gas-phase tropospheric chemistry, *Crit. Rev. Env. Sci. Tec.*, 34, 1–108, 2004.
- Creasey, D. J., Halford-Maw, P. A., Heard, D. E., Pilling, M. J., and Whitaker, B. J.: Implementation and initial deployment of a field instrument for measurement of OH and HO₂ in the troposphere by laser-induced fluorescence, *J. Chem. Soc., Faraday Trans.*, 93, 2907–2913, 1997.
- Creasey, D. J., Halford-Maw, P. A., Heard, D. E., Spence, J. E., and Whitaker, B. J.: Fast photomultiplier tube gating system for photon counting applications, *Rev. Sci. Instrum.*, 69, 4068–4073, 1998.
- Dorn, H.-P., Neuroth, R., and Hofzumahaus, A.: Investigation of OH absorption cross sections of rotational transitions in the A²Σ⁺, v'=0 ← X²Π, v'=0 band under atmospheric conditions: Implications for tropospheric long-path absorption measurements, *J. Geophys. Res.*, 100, 7397–7409, 1995.
- Dubey, M. K., Hanisco, T. F., Wennberg, P. O., and Anderson, J. G.: Monitoring potential photochemical interference in laser-induced fluorescence measurements of atmospheric OH, *Geophys. Res. Lett.*, 23, 3215–3218, 1996.
- Dusanter, S., Vimal, D., and Stevens, P. S.: Technical note: Measuring tropospheric OH and HO₂ by laser-induced fluorescence at low pressure, A comparison of calibration techniques, *Atmos. Chem. Phys.*, 8, 321–340, 2008, <http://www.atmos-chem-phys.net/8/321/2008/>.
- Dusanter, S., Vimal, D., Stevens, P. S., et al.: Measurements of OH and HO₂ Concentrations during the MCMA-2006 Field Campaign: Part 2 – Model Comparison and Radical Budget, *Atmos. Chem. Phys. Discuss.*, in preparation, 2009.
- Emmerson, K. M., Carslaw, N., Carpenter, L. J., Heard, D. E., Lee, J. D., and Pilling, M. J.: Urban atmospheric chemistry during the PUMA campaign 1: Comparison of modelled OH and HO₂ concentrations with measurements, *J. Atmos. Chem.*, 52, 143–164, 2005a.

- Emmerson, K. M., Carslaw, N., and Pilling, M. J.: Urban atmospheric chemistry during the PUMA campaign 2: Radical budgets for OH, HO₂ and RO₂, *J. Atmos. Chem.*, 52, 165–183, 2005b.
- Emmerson, K. M., Carslaw, N., Carslaw, D. C., Lee, J. D., McFiggans, G., Bloss, W. J., Gravestock, T., Heard, D. E., Hopkins, J., Ingham, T., Pilling, M. J., Smith, S. C., Jacob, M., and Monks, P. S.: Free radical modelling studies during the UK TORCH Campaign in Summer 2003, *Atmos. Chem. Phys.*, 7, 167–181, 2007, <http://www.atmos-chem-phys.net/7/167/2007/>.
- Faloona, I. C., Tan, D., Brune, W. H., Jaegle, L., Jacob, D. J., Kondo, Y., Koike, M., Chatfield, R., Poeschel, R., Ferry, G., Sachse, G., Vay, S., Anderson, B., Hannon, J., and Fuelberg, H.: Observations of HO_x and its relationship with NO_x in the upper troposphere during SONEX, *J. Geophys. Res.*, 105(D3), 3771–3783, 2000.
- Faloona, I. C., Tan, D., Leshner, R. L., Hazen, N. L., Frame, C. L., Simpas, J. B., Harder, H., Martinez, M., Di Carlo, P., Ren, X., and Brune, W. H.: A Laser-Induced Fluorescence Instrument for Detecting Tropospheric OH and HO₂: Characteristics and Calibration, *J. Atmos. Chem.*, 47, 139–167, 2004.
- Fenske, J. D., Hasson, A. S., Paulson, S. E., Kuwata, K. T., Ho, A., and Houk, K. N.: The pressure dependence of the OH radical yield from ozone-alkene reactions, *J. Phys. Chem. A*, 104, 7821–7833, 2000.
- Fuchs, H., Brauers, T., Häsel, R., Holland, F., Mihelcic, D., Müsgen, P., Rohrer, F., Wegener, R., and Hofzumahaus, A.: Intercomparison of peroxy radical measurements obtained at atmospheric conditions by laser-induced fluorescence and electron spin resonance spectroscopy, *Atmos. Meas. Tech. Discuss.*, 1, 375–399, 2008, <http://www.atmos-meas-tech-discuss.net/1/375/2008/>.
- George, L. A., Hard, T. M., and O'Brien, R. J.: Measurement of free radicals OH and HO₂ in Los Angeles smog, *J. Geophys. Res.*, 104, 11643–11655, 1999.
- Hard, T. M., George, L. A., and O'Brien, R. J.: FAGE determination of tropospheric HO and HO₂, *J. Atmos. Sci.*, 52, 3354–3371, 1995.
- Hard, T. M., George, L. A., and O'Brien, R. J.: An Absolute Calibration for Gas-Phase Hydroxyl Measurements, *Environ. Sci. Technol.*, 36, 1783–1790, 2002.
- Heard, D. E. and Pilling, M. J.: Measurement of OH and HO₂ in the troposphere, *Chem. Rev.*, 103, 5163–5198, 2003.
- Heard, D. E., Carpenter, L. J., Creasey, D. J., Hopkins, J. R., Lee, J. D., Lewis, A. C., Pilling, M. J., Seakins, P. W., Carslaw, N., and Emmerson, K. M.: High levels of the hydroxyl radical in the winter urban troposphere, *Geophys. Res. Lett.*, 31, L18112, doi:10.1029/2004GL020554, 2004.
- Hofzumahaus, A., Aschmutat, U., Heßling, M., Holland, F., and Ehhalt, D. H.: The measurement of tropospheric OH radicals by laser-induced fluorescence spectroscopy during the POPCORN field campaign, *Geophys. Res. Lett.*, 23, 2541–2544, 1996.
- Holland, F., Hessling, M., and Hofzumahaus, A.: In situ measurement of tropospheric OH radicals by laser-induced fluorescence – A description of the KFA instrument, *J. Atmos. Sci.*, 52, 3393–3401, 1995.
- Holland, F., Hofzumahaus, A., Schäfer, J., Kraus, A., and Pätz, H.-W.: Measurements of OH and HO₂ radical concentrations and photolysis frequencies during BERLIOZ, *J. Geophys. Res.*, 108, 8246, doi:10.1029/2001JD001393, 2003.
- Kanaya, Y., Sadanaga, Y., Hirokawa, J., Kajii, Y., and Akimoto, H.: Development of a ground-based LIF instrument for measuring HO_x radicals: Instrumentation and calibrations, *J. Atmos. Chem.*, 38, 73–110, 2001.
- Kanaya, Y., Cao, R., Akimoto, H., Fukuda, M., Komazaki, Y., Yokouchi, Y., Koike, M., Tanimoto, H., Takegaya, N., and Kondo, Y.: Urban photochemistry in central Tokyo: 1. Observed and modeled OH and HO₂ radical concentrations during the winter and summer 2004, *J. Geophys. Res.*, 112, doi:10.1029/2007JD008670, 2007.
- Konrad, S., Schmitz, T., Buers, H.-J., Houben, N., Mannschreck, K., Mihelcic, D., Musgen, P., Patz, H.-W., Holland, F., Hofzumahaus, A., Schafer, H.-J., Schroder, S., and Volz-Thomas, A.: Hydrocarbon measurements at Pabstthum during the BERLIOZ campaign and modeling of free radicals, *J. Geophys. Res.*, 108, 8251, doi:10.1029/2001JD000866, 2003.
- Kroll, J. H., Clarke, J. S., Donahue, N. M., Anderson, J. G., and Demerjian, K. L.: Mechanism of HO_x formation in the gas-phase ozone-alkene reaction. 1. Direct pressure-dependent measurements of prompt OH yields, *J. Phys. Chem. A*, 105, 1554–1560, 2001a.
- Kroll, J. H., Sahay, S. R., Anderson, J. G., Demerjian, K. L., and Donahue, N. M.: Mechanism of HO_x formation in the gas-phase ozone-alkene reaction. 2. Prompt versus thermal dissociation of carbonyl oxides to form OH, *J. Phys. Chem. A*, 105, 4446–4457, 2001b.
- Levy, H.: Normal atmosphere: large radical and formaldehyde concentrations predicted, *Science*, 173, 141–143, 1971.
- Levy, H.: Photochemistry of the lower troposphere, *Planet. Space Sci.*, 20, 919–935, 1972.
- Martinez, M., Harder, H., Kovacs, T. A., Simpas, J. B., Bassis, J., Leshner, R., Brune, W. H., Frost, G. J., Williams, E. J., Stroud, C. A., Jobson, B. T., Roberts, J. M., Hall, S. R., Shetter, R. E., Wert, B., Fried, A., Alicke, B., Stutz, J., Young, V. L., White, A. B., and Zamora, R. J.: OH and HO₂ concentrations, sources, and loss rates during the Southern Oxidants Study in Nashville, Tennessee, summer 1999, *J. Geophys. Res.*, 108, 4617, doi:10.1029/2003JD003551, 2003.
- Martinez, M., Harder, H., Ren, X., Leshner, R. L., and Brune, W. H.: Measuring atmospheric naphthalene with laser-induced fluorescence, *Atmos. Chem. Phys.*, 4, 563–569, 2004.
- Mao, J., Ren, X., Chen, S., Brune, W. H., Chen, Z., Martinez, M., Harder, H., Lefter, B., Rappenglück, B., Flynn, J., and Leuchner, M.: Atmospheric Oxidation Capacity in the Summer of Houston 2006: Comparison with Summer Measurements in Other Metropolitan Studies, *Atmos. Environ.*, doi:10.1016/j.atmosenv.2009.01.013, 2009.
- Mather, J. H., Stevens, P. S., and Brune, W. H.: OH and HO₂ measurements using laser-induced fluorescence, *J. Geophys. Res.*, 102, 6427–6436, 1997.
- Molina, L. T. and Molina, M. J.: Air Quality in the Mexico Megacity: An Integrated Assessment, Kluwer Academic Publishers: Dordrecht, The Netherlands, 384 pp., 2002.
- Molina, L. T., Kolb, C. E., de Foy, B., Lamb, B. K., Brune, W. H., Jimenez, J. L., Ramos-Villegas, R., Sarmiento, J., Paramo-Figueroa, V. H., Cardenas, B., Gutierrez-Avedoy, V., and Molina, M. J.: Air quality in North America's most populous city – overview of the MCMA-2003 campaign, *Atmos. Chem. Phys.*,

- 7, 2447–2473, 2007,
<http://www.atmos-chem-phys.net/7/2447/2007/>.
- Molina, M. J. and Molina, L. T.: Megacities and atmospheric pollution, *J. Air Waste Manag. Assoc.*, 54, 644–680, 2004.
- Paulson, S. E. and Orlando, J. J.: The reactions of ozone with alkenes: An important source of HO_x in the boundary layer, *Geophys. Res. Lett.*, 23, 3727–3730, 1996.
- Platt, U., Alicke, B., Dubois, R., Geyer, A., Hofzumahaus, A., Holland, F., Martinez, M., Mihelcic, D., Klupfel, T., Lohrmann, B., Patz, W., Perner, D., Rohrer, F., Schafer, J., and Stutz, J.: Free radicals and fast photochemistry during BERLIOZ, *J. Atmos. Chem.*, 42, 359–394, 2002.
- Raga, G. B. and Raga, A. C.: On the formation of an elevated ozone peak in Mexico City, *Atmos. Environ.*, 34, 4097–4102, 2000.
- Ren, X., Edwards, G. D., Cantrell, C. A., Leshner, R. L., Metcalf, A. R., Shirley, T., and Brune, W. H.: Intercomparison of peroxy radical measurements at a rural site using laser-induced fluorescence and Peroxy Radical Chemical Ionization Mass Spectrometer (PerCIMS) techniques, *J. Geophys. Res.*, 108, 4605, 2003a.
- Ren, X., Harder, H., Martinez, M., Leshner, R. L., Oliger, A., Shirley, T., Adams, J., Simpas, J. B., and Brune, W. H.: HO_x concentrations and OH reactivity observations in New York City during PMTACS-NY2001, *Atmos. Environ.*, 37, 3627–3637, 2003b.
- Ren, X., Harder, H., Martinez, M., Leshner, R. L., Oliger, A., Simpas, J. B., Brune, W. H., Schwab, J. J., Demerjian, K. L., He, Y., Zhou, X., and Gao, H.: OH and HO₂ Chemistry in the urban atmosphere of New York City, *Atmos. Environ.*, 37, 3639–3651, 2003c.
- Ren, X., Harder, H., Martinez, M., Faloona, I. C., Tan, D., Leshner, R. L., Di Carlo, P., Simpas, J. B., and Brune, W. H.: Interference Testing for Atmospheric HO_x Measurements by Laser-induced Fluorescence, *J. Atmos. Chem.*, 47, 169–190, 2004.
- Ren, X., Brune, W. H., Mao, J., Mitchell, M. J., Leshner, R. L., Simpas, J. B., Metcalf, A. R., Schwab, J. J., Cai, C., Li, Y., Demerjian, K. L., Felton, H. D., Boynton, G., Adams, A., Perry, J., He, Y., Zhou, X., and Hou, J.: Behavior of OH and HO₂ in the winter atmosphere in New York City, *Atmos. Environ.*, 40, S252–S263, 2006.
- Shirley, T. R., Brune, W. H., Ren, X., Mao, J., Leshner, R., Cardenas, B., Volkamer, R., Molina, L. T., Molina, M. J., Lamb, B., Velasco, E., Jobson, T., and Alexander, M.: Atmospheric oxidation in the Mexico City Metropolitan Area (MCMA) during April 2003, *Atmos. Chem. Phys.*, 6, 2753–2765, 2006,
<http://www.atmos-chem-phys.net/6/2753/2006/>.
- Stevens, P. S., Mather, J. H., and Brune, W. H.: Measurements of tropospheric OH and HO₂ by laser-induced fluorescence at low pressure, *J. Geophys. Res.*, 99, 3543–3557, 1994.
- Volkamer, R., Sheehy, P. M., Molina, L. T., and Molina, M. J.: Oxidative capacity of the Mexico City atmosphere – Part 1: A radical source perspective, *Atmos. Chem. Phys. Discuss.*, 7, 5365–5412, 2007,
<http://www.atmos-chem-phys-discuss.net/7/5365/2007/>.
- Wennberg, P. O., Hanisco, T. F., Cohen, R. C., Stimpfle, R. M., Lapon, L. B., and Anderson, J. G.: In situ measurements of OH and HO₂ in the upper troposphere and stratosphere, *J. Atmos. Sci.*, 52, 3413–3420, 1995.